



Design **guidebook**

Delivery systems for cryogenic liquids
in laboratories



Contents

Commercial & design considerations

1. Types of cryogenic piping.....	04
2. Selecting the proper distribution system.....	06
3. Heat Loss = Nitrogen Loss.....	07
4. The importance of controlling pressure.....	08
5. Cryogenic piping design the golden rules.....	11
6. Collecting all vent pipes to a common discharge.....	12
7. Example of an isometric drawing.....	13
8. Discovery cryogenic supply.....	15

Equipment

9. Static (sealed) vacuum jacketed piping.....	18
10. Vapor vent for a better liquid nitrogen quality.....	20
11. Vapor vent heater preventing ice build ups.....	21
12. Non-vacuum insulated components.....	22
13. Fully automatic switchover manifolds cryogenic liquid withdraw & dispense.....	24
14. Automatic filling liquid cylinder fill station.....	26
15. Temperature control unit (Keepcool)-The time saver.....	27
16. The pusher-Controlling the pressure of a liquid cylinder.....	28
17. Vent kits-Balancing pressure between several liquid cylinders.....	30
18. Ambient vaporizers-Turning small volume of liquid into a lot of gas.....	32

Applications

19. Controlled Rate Freezers (CRF) More complicated than they look.....	34
20. Cryogenic storage freezer-Importance of fill time.....	35
21. The time sensitive stationary storage freezers.....	36
22. Manual fill station for liquid nitrogen dewars.....	37
23. VJ piping installation-So simple.....	38

**Commercial
& design
considerations**

Types of cryogenic piping

1. Foam insulated pipe

Despite the moisture barrier, a layer of moisture is building up between the carrier pipe and the polyurethane foam. This moisture freezes up when liquid nitrogen is in the pipe. The ice expands and breaks the insulation rapidly.

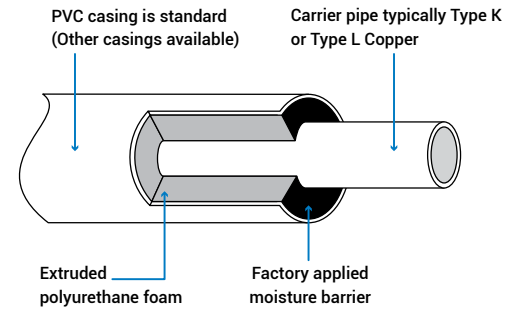

Characteristics

- Low cost to purchase
- Standard length of pipes
- Short delivery lead time
- High heat leak rate
- 5-7 years life time
- Silver brazing required during installation
- Field insulation of tees, couplings, elbows, crosses
- Only non-VJ valves

2. Dynamic vacuum

A dynamic vacuum jacketed piping implies that a pump is used to evacuate and holds the vacuum insulation (the annular space) at the **end user's site**.

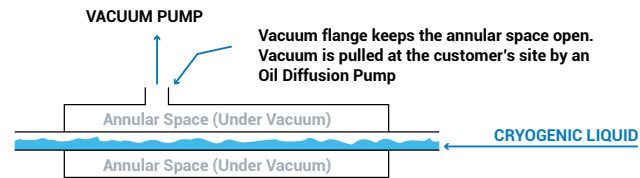

Characteristics

- The primary characteristic of dynamic vacuum piping systems is that the vacuum level inside the annular space is maintained by a vacuum pump at customer sites
- The annular space of each spool are inter-connected to each other by a section of corrugated flexible conduit (shown on the drawing as "vacuum jumper")
- Dynamic vacuum jacketed piping are often populated by several flexible hoses serving as main conduits
- It is very common to see copper in a corrugated form as the inner (wetted) material
- Dynamic vacuum piping and components are generally kept in stock at standardized lengths to allow for short lead times
- The vacuum pump is an oil diffusion type that requires maintenance such as oil changes
- Electricity (generally 115 VAC) required to run the vacuum pump is an operating expense to the owner
- Unlike static (sealed) vacuum systems, there are no superinsulation and no gas getters inside the annular space (hence the need for a vacuum pump)

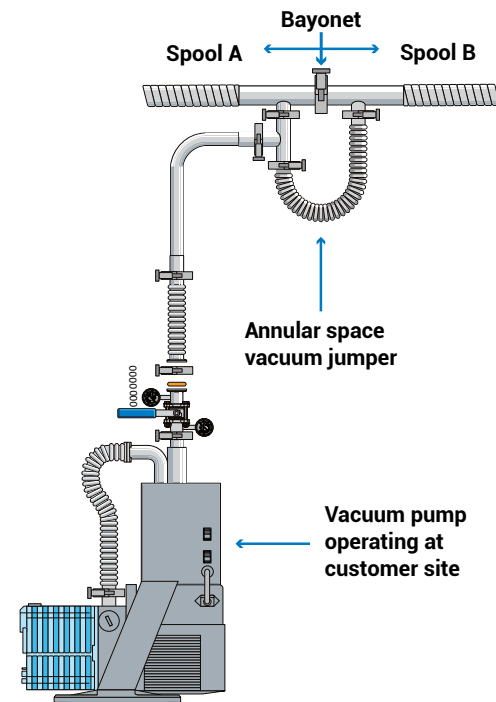

3. Static (Sealed) vacuum

As shown, the vacuum is pumped in the annular space at the **factory** where the piping is made. The vacuum pump-out device prevents any molecules to go in or out of the annular space.

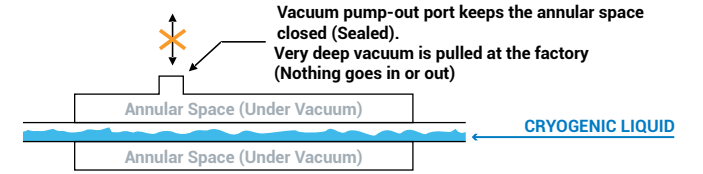

Characteristics

- A pipe section is called a "spool"
- The entire job is precisely measured by the installer
- Isometric drawings are made as per the measurements provided by the installer. The isometric drawings show all critical measurements and the location of valves, bayonets, and pressure relief valves
- The installer is required to confirm each measurement shown on the isometrics
- Once all measurements are confirmed, the installer is required to sign off the isometrics to start constructions
- The spools are linked together using male and female bayonets
- All the spools are delivered by truck ready for installation



Comparing static vacuum & dynamic vacuum insulated pipes

Comparison criteria	Static vacuum	Dynamic vacuum	Comments
Vacuum level	1 x 10 ⁻⁶ torr	1 x 10 ⁻⁶ torr	Vacuum pumps used at VJ piping manufacturing facilities are way more effective at pulling vacuum than the ones used at customer sites
Application of heat during the evacuation process	Yes	No	Applying heat inside the carrier pipe during the evacuation process greatly improves the removal of hidden molecules from the annular space
Utilities required to operate the vacuum pump	None	Yes <ul style="list-style-type: none"> • Electricity to run the vacuum pump • Floor space for the vacuum pump 	One of the cost to own a dynamic vacuum system is related to power the vacuum pump
Chemical getters (aka gas traps) normally Zeolite	Yes	No <ul style="list-style-type: none"> • Usually no gas traps or otherwise they get saturated rapidly 	The gas traps are essential to minimize heat transfer in the annular space
Installation time	Bayonets for VJ pipe	<ul style="list-style-type: none"> • Bayonets for the VJ pipe • Vacuum fittings for the annular space • Vacuum pump installation 	Dynamic vacuum piping systems require more time and more hardware to install compared to static vacuum jacketed piping
Maintenance requirements	None	Yes <ul style="list-style-type: none"> • Routine oil change • Vacuum pump normal maintenance 	The other cost to own a dynamic vacuum system is related to both oil changes, pump maintenance and associated labor

Selecting the proper distribution system

Pay more now or pay way more later

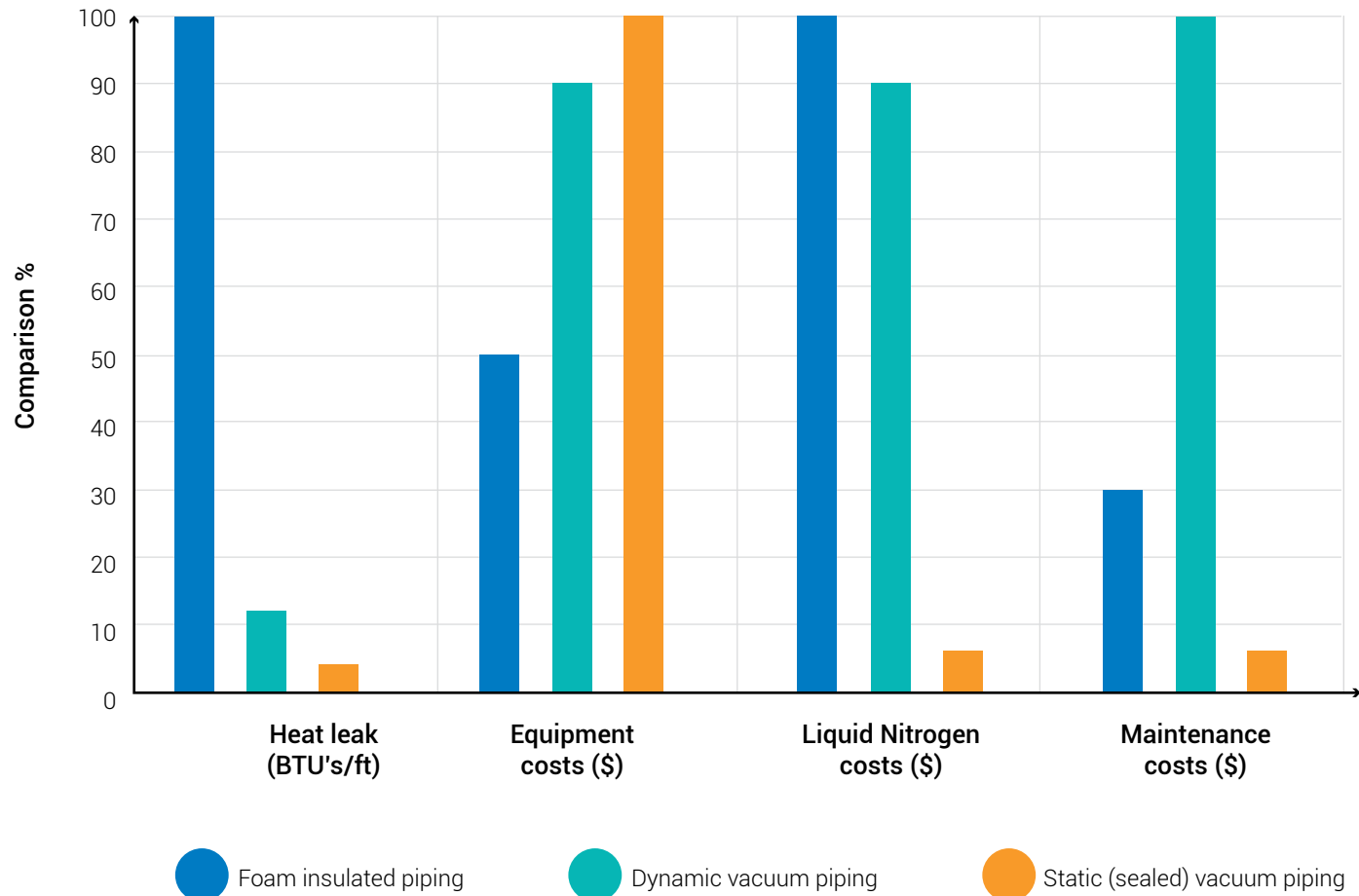

Conclusion

It appears very clear that static vacuum jacketed piping is a better choice over dynamic vacuum jacketed piping. Static vacuum jacketed pipes have been sold around the world for several decades now. Static vacuum is a proven technology. It is technically sound and the cost to own is by far the lowest of any other type of insulated pipes for cryogenic applications including dynamic vacuum jacketed pipes.

Most if not all manufacturers of vacuum jacketed piping offer static vacuum jacketed pipes and very few (most probably only one) offer dynamic vacuum jacketed pipes. The static vacuum technology is not only used for piping, but it is also widely used for other type of cryogenic equipment such as cryogenic freezers and cryogenic tanks like the ones you see holding large amounts of liquid oxygen at hospitals.

In our opinion, the lower cost to purchase of a dynamic vacuum jacketed piping versus a static vacuum jacketed piping is rapidly offset by its total lower cost of ownership

Heat Loss = Nitrogen Loss

Heat loss comparison between piping type - 1" Pipe

BARE COPPER PIPE	FOAM INSULATED PIPE	DYNAMIC VACUUM INSULATED PIPE	STATIC VACUUM INSULATED PIPE
200.00 BTU/hr-ft 192.30 Watts/min.	20.00 BTU/hr-ft 19.40 Watts/min.	4.00 BTU/hr-ft 3.90 Watts/min.	0.45 BTU/hr-ft 0.43 Watts/min.

Pay now or pay way more later

The table above does not require very lengthy explanations and complicated calculations to determine which piping technology is the best to carry a cryogenic fluid from one point to the other. What is less obvious is to translate how much this heat loss will cost in liquid nitrogen.

So, let's do simple math to determine how much it costs in liquid nitrogen just because of simple heat loss:

Latent heat of vaporization of nitrogen:
85.6 BTU/lb

Length of 1" NPS piping **100 ft**
(Straight length - No joints to ease calculations)

Price of Liquid Nitrogen **\$0.05 /lb**

Formulas

$$\text{Heat loss per hour} = \frac{\text{Heat loss per hour per foot of pipe}}{\text{per foot of pipe}} \times 100 \text{ ft of piping}$$

$$\text{Yearly cost of heat loss} = \frac{\text{Heat loss per hour} \times \$0.05 \text{ per lb} \times 24 \text{ hours per day} \times 365 \text{ days per year}}{85.6 \text{ BTU/lb}}$$

Results

- Non-insulated copper pipe : **\$ 102,336**
- Foam insulated copper pipe : **\$ 10,233**
- Dynamic vacuum piping : **\$ 2,046**
- Static vacuum piping : **\$ 230**

Other important sources of heat loss due to non-vacuum insulated components

This quick example CLEARLY shows how important is to keep a liquid nitrogen delivery system well insulated. There are several other non-vacuum jacketed components that are significant heat leak sources (and they all add up).

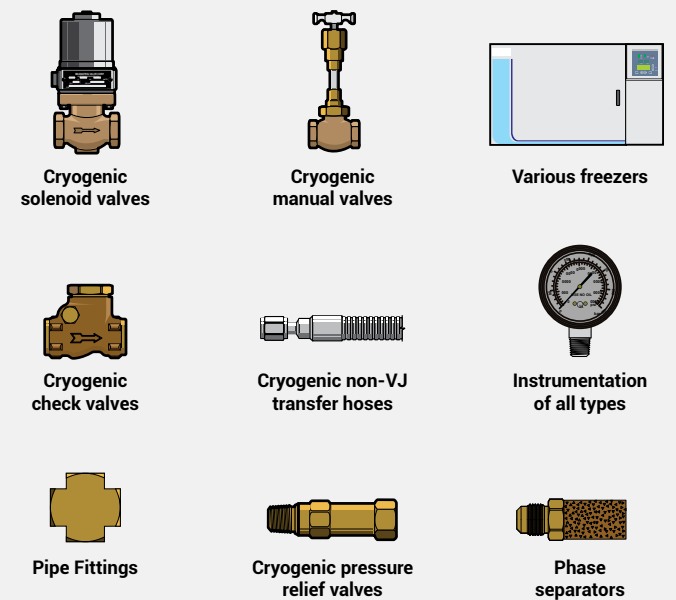

It's all about performance or lack thereof

The performance of a cryogenic delivery system is not only about dollars and cents.

- **Extended fill time** of cryogenic storage freezers
- **Back pressure** to controlled rate freezers
- **Condensation, ice build-up, dripping and thawing** of water and moisture on non-VJ components and floor inside a cleanroom (sometimes this is not allowed at all)



The importance of controlling pressure

Pressure impacts flow rate

Most of us have noticed when pressure is low from the water tap, the flow of the water is also reduced. The lower the pressure, the lower the flow. This is true for any type of fluid (gas or liquid) including liquid nitrogen.

Why is it important?

At too low of a pressure, liquid nitrogen will take a lot of time to travel inside the piping.

Pressure impacts liquid nitrogen quality (PV = nRT)

This formula is known as the Ideal Gas Law. It is a combination of several laws elaborated by Boyle, Charles, Gay-Lussac, and Avogadro. What is important to understand is the correlation between P and T. When pressure (P) increases, the temperature (T) increases.

In the case of a cryogenic fluid, if the pressure increases too much, the temperature gets closer to the boiling point. The liquid then gets saturated with gas before the gaseous molecules escape the liquid phase.

This represents a pressure loss of 5.4 psi just to fight gravity. Pressure loss due to length of piping, friction, fittings, and valves are not taken into account in the final pipeline pressure.

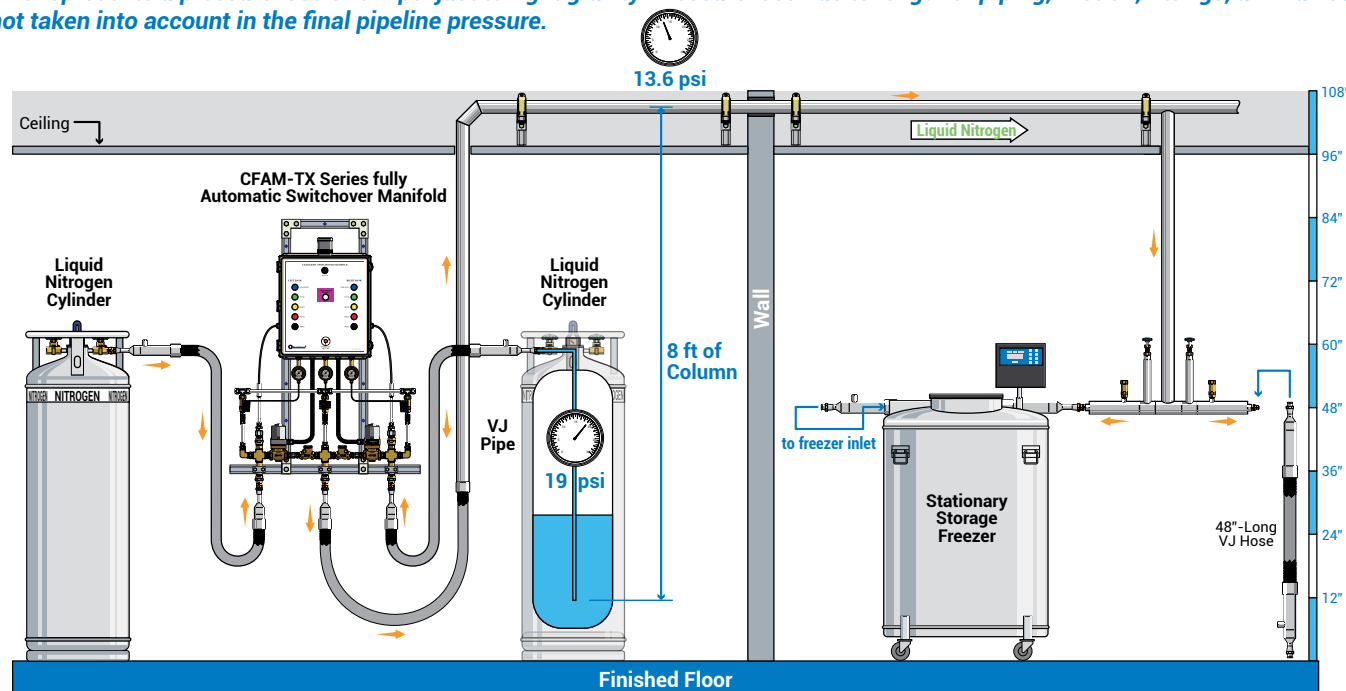

Fig. A: Elevated piping cause the pressure to decrease as liquid nitrogen is pulled down by gravitational force.

Undesirable side effects of highly saturated cryogenic liquid nitrogen

Bad Heat Transfer

Nitrogen BTU transfer happens in three different ways:

- In the liquid phase
- In the gas phase
- During the change of phase (going from liquid to gas)

It is important to know that gas saturated liquid nitrogen has a lower heat transfer "index" compared to good quality liquid nitrogen which contains less nitrogen "bubbles". This is particularly important when liquid nitrogen is used to feed controlled rate freezers.

Flash Loss

Flash loss occurs when liquid nitrogen with entrained gas goes from a higher-pressure to a lower-pressure. This is primarily noticeable when open flask dewars are being filled with liquid nitrogen at too high of a pressure. This is similar to when water comes out of a garden hose with air trapped in it.

Why is it important?

A pressure too high will cause pre-mature liquid nitrogen boil-off resulting in poor heat transfer and flash loss.

What is the ideal pressure?

This question is simple and complicated to answer depending on the application.

- Many **controlled rate freezers** have pressure relief valves set at 22 psi. Because of that, 19 psi is low enough to keep the safety relief valve from opening. At this pressure, the species, vials, bags and straws are not exposed to pressure that could damage them. Finally, at 19 psi, the fill rate allows the seeding dip to be reached in a timely manner
- The most popular brand of **storage cryogenic freezers** is indicating in their operation manuals that the best supply pressure range is between 20-40 psi. This is very important for two reasons:
 - This pressure range assures adequate re-fill time of the freezer
 - This highlight a very important technical problem when the supply source is liquid cylinders. Liquid cylinders for liquid nitrogen supply are mounted with 22 psi relief valves

Thing to remember - Controlled rate freezer

17-21 psi is the range where VJ piping should be kept. The best pressure for a being 19 psi.

Thing to remember - Storage freezer

20-40 psi is the range where VJ piping should be kept. Try to keep the pressure as low as possible to minimize flash loss and keep good liquid nitrogen quality.

Thing to remember

Keep the pressure stable to get a steady flow. This is particularly true with liquid cylinders as a source of liquid nitrogen.

Fighting gravity

Gravity is a much bigger deal than one may think. As an example, we know empirically and mathematically that the pressure loss due to gravity of a 1/2" vacuum jacketed pipe (the inner conduit that is) is around 0.7 psi per foot of column. Figure A on the previous page shows the impact of gravity on the pipeline pressure.

The configuration and the height at which VJ piping can be installed is often dictated by the physical constraints of the facility where it is installed.

Thing to remember

Keep the VJ piping elevation as low as possible to minimize the pressure loss due to gravity.

Controllable and steady pressure

If you are feeding controlled rate freezers with liquid nitrogen. It is paramount to maintain a stable flow. One way of doing it is by controlling the head pressure of the liquid cylinder (stable pressure = steady flow).

Although not as important for controlled rate freezers, keeping a steady pressure of the liquid nitrogen inside the VJ piping provides a predictable fill pattern to stationary storage freezers.

If the source of liquid nitrogen is liquid cylinders, it is **very difficult** to control the gas head space just by using the PB regulator of the liquid cylinders. The best and easiest way to control pressure is to use a **pusher**.

Cryogenic piping design the golden rules

This represents a pressure loss of 2.8 psi just to fight gravity. Pressure loss due to length of piping, friction, fittings, and valves are not taken into account in the final pipeline pressure.

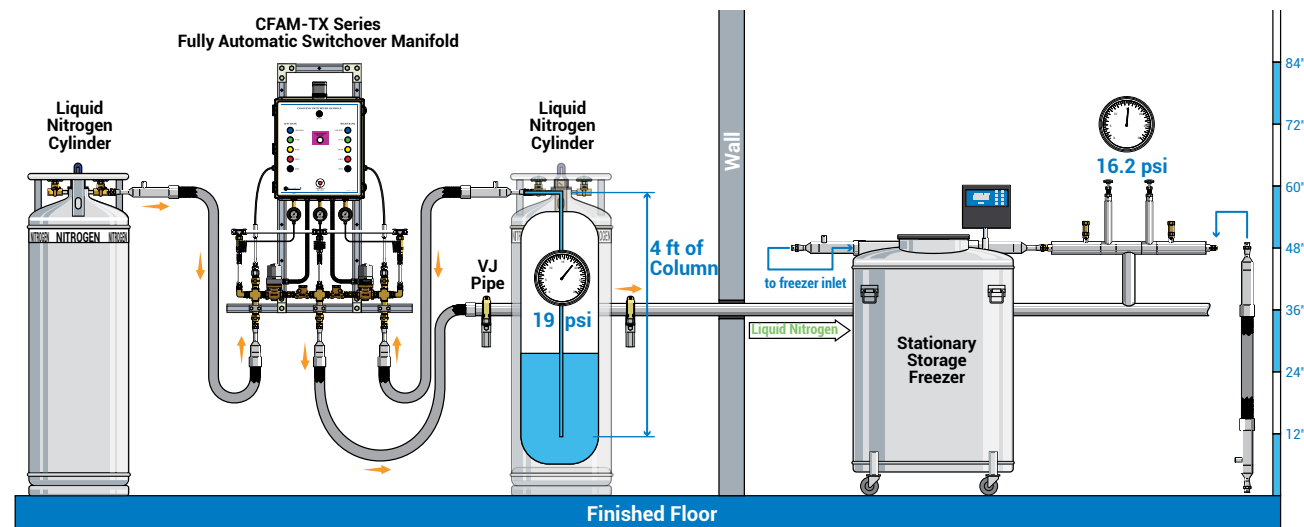

Fig. B: Elevated piping cause the pressure to decrease as liquid nitrogen is pulled down by gravitational force.

The "Golden Rules" are a set of high level recommendations regarding the design of cryogenic piping. The "rules" are based on the physical properties of cryogenic liquids in relation to their impacts on safety and basic engineering.

Prefer vacuum jacketed insulation over foam insulated piping

- Vacuum Jacketed pipes have a much better heat leak rate

Prefer static vacuum over dynamic vacuum

- Dynamic vacuum pipes require a diaphragm pump (maintenance, energy, space, heat leak)

Go with bayonet over field welded

- Field welded joints use layered insulation (higher heat leak rate)

Size piping diameter adequately

- Too BIG... More expensive to purchase and require more cryogen to cool down
- Too SMALL... Flow restriction

Always use cryogenic rated components

- If it is not rated "Cryogenic"... it's NOT

Keep piping short, straight and low

Avoid long runs and minimize elevation to:

- Minimize heat leak
- Keep cost low
- Reduce pressure loss due to gravity

Seek for design assistance

- Designing VJ piping networks may seem easy but it is rarely the case

Never trap cryogenic liquid in a pipe

Reason: Thermal expansion

- Liquid will convert to gas and pressure will increase drastically which is likely to burst the pipe or pipe components

Never use carbon steel

Reason: Cold embrittlement

- Carbon steel piping and components may break in cryogenic temperature stainless steel is the best metal

Never use rubber

Reason: Cold embrittlement

- Rubber or rubber-like materials are likely to get pulverized under cryogenic temperature... use TEFLON

Pipe away safety relief valves

Reason: Thermal expansion and oxygen depletion

- Don't forget to insulate the vent pipe if necessary

Only stainless steel hoses

Reason: Cold embrittlement

- Nothing else is good...period

Cryogenic and cheap

- It is hard to put these two words in the same sentence



Collecting all vent pipes to a common discharge

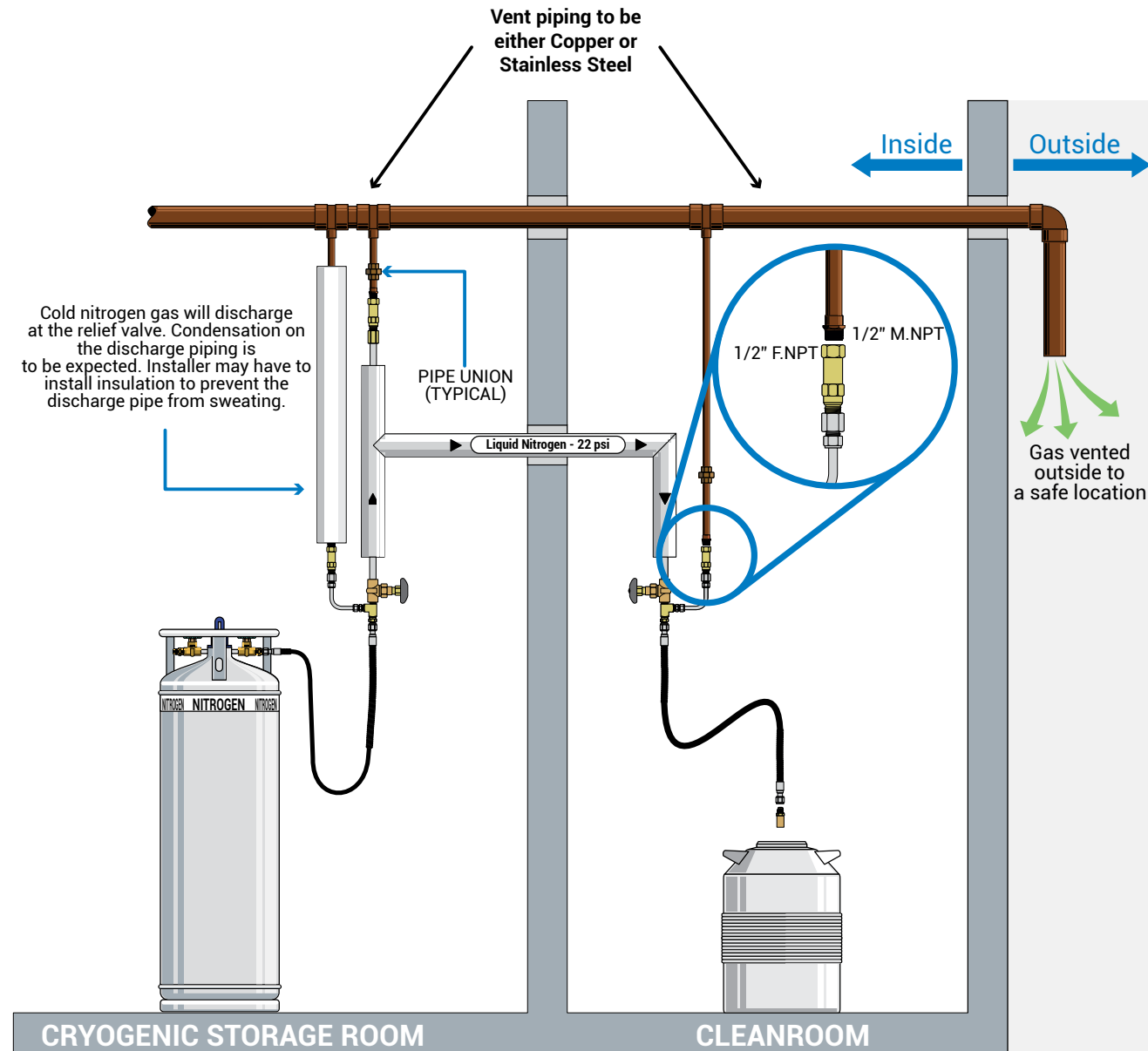

It's a matter of common sense

Cryogenic liquid delivery systems are normally populated with several thermal expansion pressure relief valves. While some rooms are big enough and/or fed with a large amount of air to prevent oxygen depletion. Most rooms require to have the relief valves to be piped away to a safe location.

In these cases, the vent piping shall follow some common sense engineering design criteria.







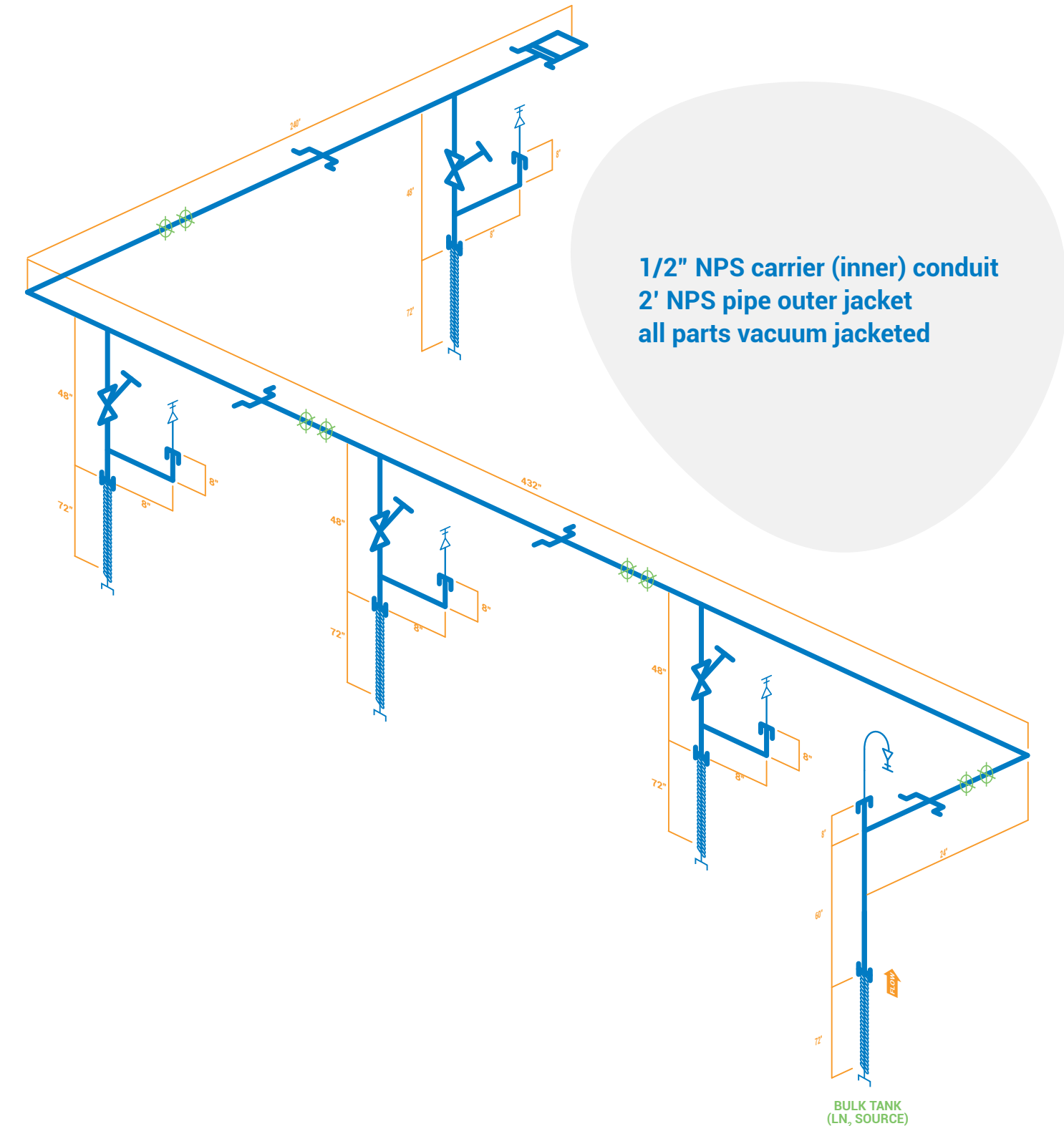

Design criteria







- Use materials capable of supporting cryogenic temperatures such as copper or stainless steel
- Do not create flow restriction or back pressure
- Avoid collecting other gases to the nitrogen vent piping
- Discharge the collector to a safe location (preferably outdoors)
- Keep the discharge pipe far from an air intake (25 ft away)
- No isolating valves shall be used downstream of any pressure relief valves
- Protect the discharge opening from birds, insects and water



Example of an isometric drawing

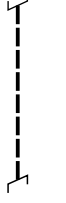

1/2" NPS carrier (inner) conduit
2' NPS pipe outer jacket
all parts vacuum jacketed

VJ Piping Legend	
	Field Joint
	Cap Bayonet
	Vacuum insulated cryogenic manual globe valve
	Bayonet
	Vacuum jacketed end 1/2" M.NPT
	Vacuum jacketed flexible hose, CGA 295 Swivel connection each end
	Vacuum jacketed flexible hose, Inlet: Welded to VJ pipe, Outlet: CGA 295 Swivel
	Keep cold (Phase separator)
	Flange

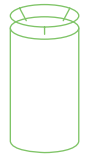
Non VJ Piping Legend	
	Thermal expansion pressure relief valve
	Spring loaded cryogenic check valve
	Extended stem cryogenic manual globe valve, bronze
	Adaptor, 1/2" M.NPT x 1/2" flare male brass
	Candy-cane with thermal expansion pressure relief valve
	Non-vacuum jacketed flexible hose CGA 295 Swivel connection each end
	Phase separator

Non Piping Legend			
	Cryogenic liquid cylinder		Indicates wall penetration
			Liquid nitrogen open flask Dewar

Specifications example

Inner line

- 1/2" nominal pipe size, schedule 5, expansion Type 304 stainless steel, joints as required

Outer Jacket

- 2" nominal pipe size, schedule 5, Type 304 stainless steel

Insulation

- Multi-layer superinsulation (vacuum jacketed)

Factory performed leak test

- Helium leak test on the entire assembly for max leak rate of 1×10^{-8} cc/sec

Field performed leak test

- The installer shall perform a field pneumatic leak test on the complete piping system at 110% of the design pressure in accordance with ASME B31.3.

Dimensions

- All dimensions are to centerline of pipe unless noted otherwise

Design code

- Per ASME B31.3 for process piping

Material certification

- Material certificates required for inner pressure piping

Discovery **cryogenic supply**

Project name:	Form completed by:	Date:
Project location:	Owner contact name:	Phone number:

List of portable liquid nitrogen open flasks (Dewars)*

Qty	Make	Model	Capacity (In litres)

* This table is provided for reference only. Most clinics own dozens of those portable liquid containers in various sizes and styles. Knowing how many containers are there to be filled will provide a clue on how big the source of liquid nitrogen will have to be.

List of stationary cryogenic freezers**

Qty	Make	Model	Capacity (In litres)

** Most clinics own only one or two freezers

List of controlled rate freezers***

Qty	Make	Model	Capacity (In litres)

*** You can expect only one controlled rate freezer per IVF clinic if any.



Questions to be answered by the owner

Question	Answer	Why this question?
What is the source of liquid nitrogen? Bulk or portable liquid cylinders		<i>Very few IVF clinics are large enough to justify a bulk liquid or even a micro-bulk liquid nitrogen storage system. a portable liquid nitrogen cylinder supply system is used in the vast majority of IVF clinics.</i>
Do you want a filling station for your portable liquid nitrogen dewars?		<i>Some IVF clinics get their portable liquid nitrogen dewars filled by a company who has a liquid nitrogen cylinder in their trucks. Most IVF clinics fill their own portable liquid dewars directly from a liquid cylinder or from liquid nitrogen pipeline.</i>
Do you want to supply your stationary cryogenic freezer VIA A manual manifold or via an uninterrupted liquid nitrogen source?		<i>Having a piece of equipment that supplies liquid nitrogen on an as-needed basis is the best method to keep semen and eggs continuously frozen. Manual supply systems rely on human monitoring for liquid nitrogen cylinder changeouts.</i>
Do you have a preference for the type of insulated piping carrying the liquid nitrogen (vacuum jacketed or foam insulated)?		<i>This question implies that the liquid nitrogen source will be in a different location than the freezers and dewars. VJ piping requires a significant up-front investment but the payback is less than 3 years compared to foam insulated piping.</i>
Some vacuum jacketed systems come with all items (primarily hoses and valves) insulated under vacuum. Is this what you want?		<i>Many IVF clinics opt for VJ piping but go with non-VJ valves and hoses to minimize the initial capital investment. Although the heat loss is significant, this type of system is still better than the foam insulated piping.</i>



Static (sealed) vacuum jacketed piping

Static vacuum jacketed insulated pipe - typical components

Despite their costs, end users chose to go with vacuum insulated pipes and related components for the following reasons:

- ✓ **Extremely low heat transfer**
(low loss of cryogenic liquid)
- ✓ **Good quality cryogenic liquid**
(minimize two-phase flow)
- ✓ **Little to no ice buildup**
(no water management)
- ✓ **Fast delivery of cryogenic liquid**
(rapid filling)

Anatomy of a static vacuum insulated pipe & related components

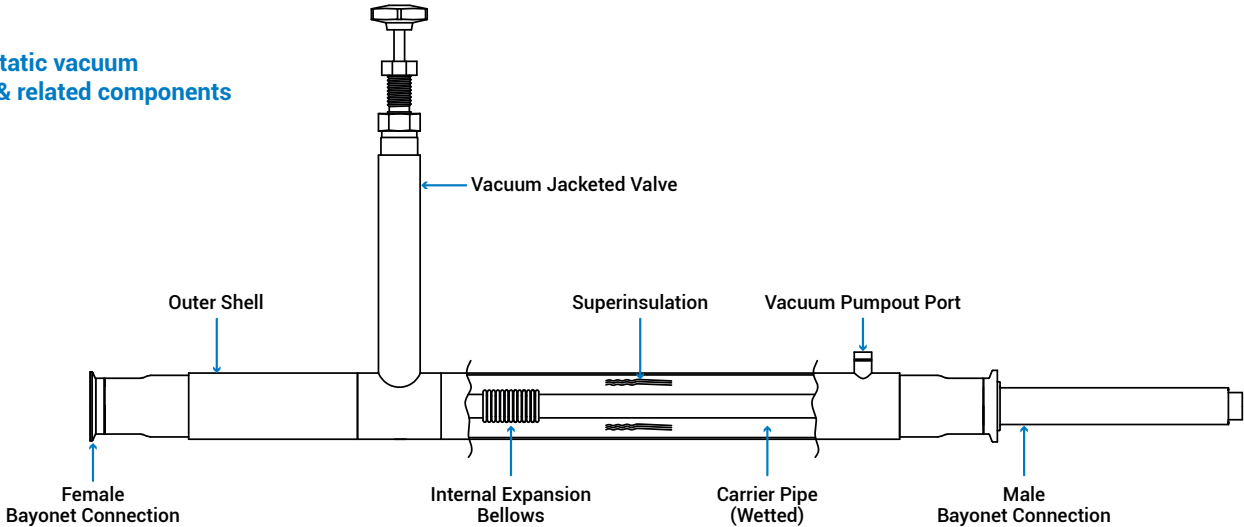

Typical vacuum insulated valves

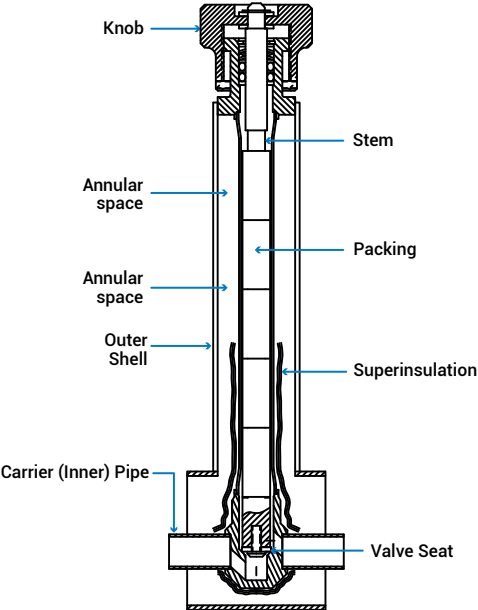

Typical vacuum insulated hose

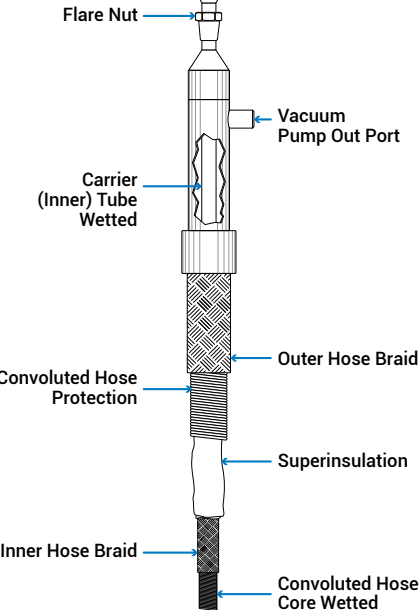

Typical vacuum insulated bayonet

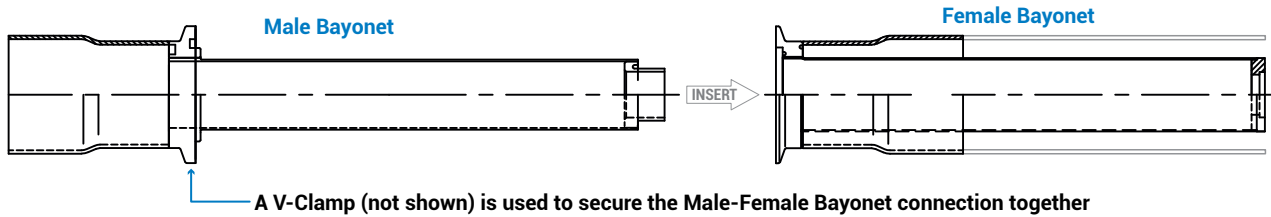

Static vacuum piping specifications

Fluid service	Liquid Nitrogen, Liquid Argon, Liquid Oxygen
Maximum working pressure	150 psig (Higher pressure rating available upon demand)
Operating temperature	-320°F to 150°F
Mechanical thermal barrier	Multiple layers of superinsulation consisting of aluminum foil and fiberglass paper
Annular space vacuum pressure	1 x 10 ⁻⁸ cc/second of Helium
Gas getter	Zeolite
Design and construction Code	Process piping - ASME B31.3 - Latest edition
Material certification	Material certification available on demand
Cleaning	Commercial cleaning (Cleaning of Oxygen service available on demand)
Material of construction	Type 304 stainless steel

Available sizes, weight, dimensions & related performance

Carrier pipe (inner) NPS schedule 5	Outside pipe (shell/jacket) NPS schedule 5	Outside diameter (inch)	Weight (lb/ft)	Cooldown (lb of LN ₂ /ft)	Heat leak - Pipe - (BTU/Hr/ft)	Heat leak - Bayonet - (BTU/Hr/ft)
1/2"	2"	2.375	2.4	0.27	0.32	6.6
1"	3"	3.500	4.2	0.43	0.45	9.1
1-1/2"	3-1/2"	4.000	5.0	0.64	0.56	13.3
2"	4"	4.500	5.8	0.80	0.75	20.9
3"	5"	5.563	9.8	1.51	0.98	28.1
4"	6"	6.625	12.0	1.96	1.28	66.1

Vapor vent for a better liquid nitrogen quality

Description

Located at a high point in a vacuum jacketed piping system, the vapor vent provides a higher quality of liquid nitrogen by removing the gas phase out of the liquid nitrogen phase. An internal float assembly controls the venting of gaseous nitrogen while retaining liquid nitrogen inside the piping.

The vacuum jacket surrounding the float assembly prevents frost and ice build-up. It is important at this point to understand that gaseous nitrogen escaping the piping is very cold. As a result, moisture surrounding the vent discharge tends to accumulate as ice on the outside of the vent pipe.

It is recommended to install a separate vapor vent heater to the vent pipe to minimize the ice build-up on the vent pipe.

Benefits of the vapor vent

There are two main benefits of installing a vapor vent:

- It provides "liquid nitrogen on demand" at the point of use as it keeps the inner pipe "full" of liquid nitrogen at all times.
- It minimizes the amount of gaseous nitrogen in the liquid nitrogen, resulting in lower liquid nitrogen temperature and lower pipeline pressures.

What's happening inside the VJ pipe?

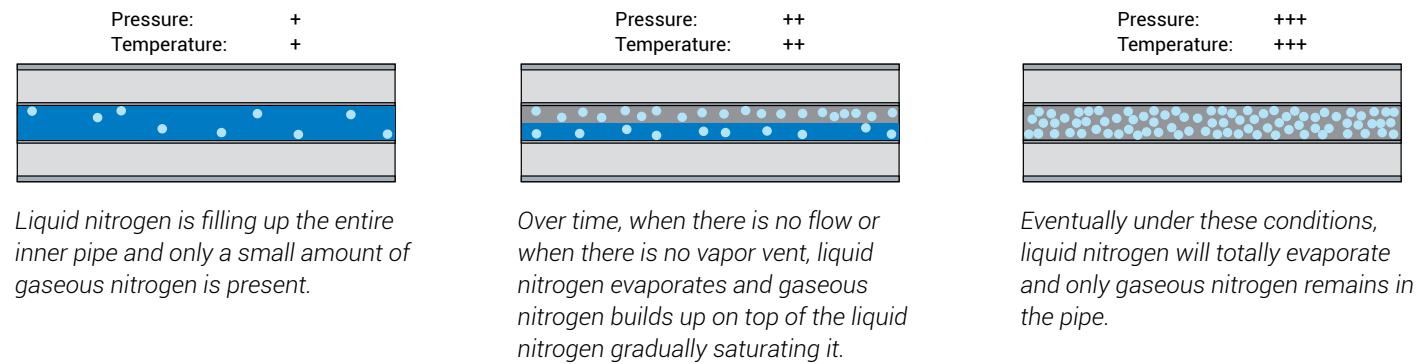

A vapor vent keeps as much liquid nitrogen as possible inside the piping by allowing the gaseous nitrogen to escape outside. The resulting liquid nitrogen remaining in the piping is less saturated with gaseous nitrogen thus better quality.

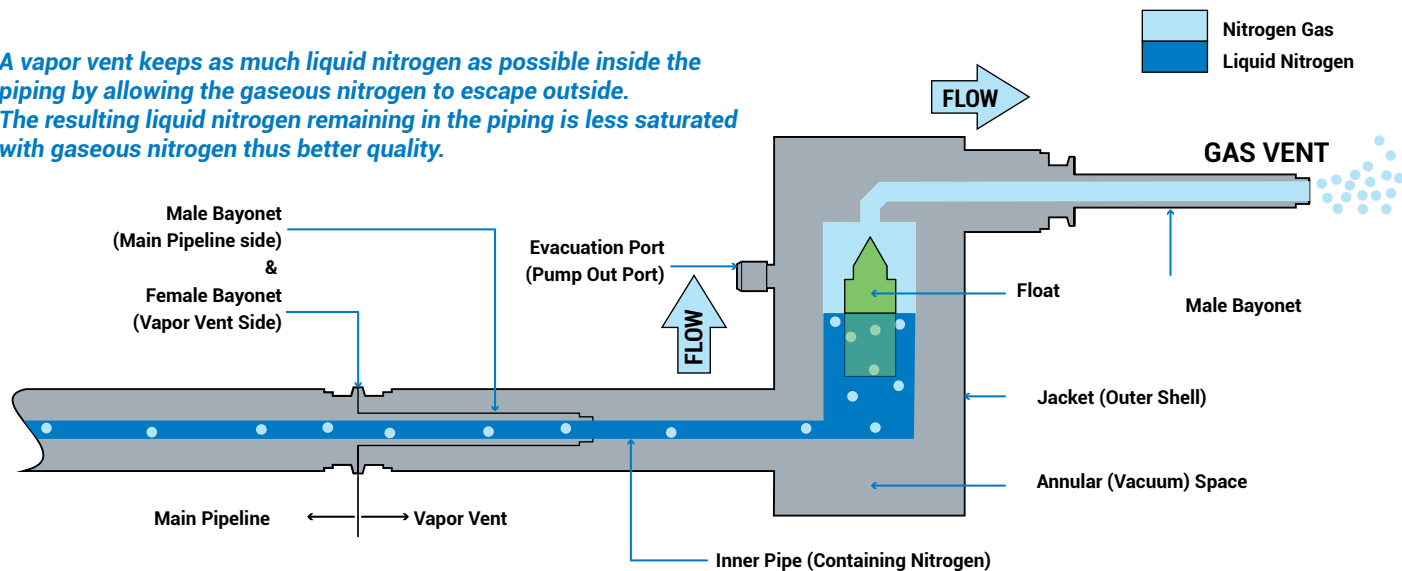

NOTE

For use with bulk supply tank only

Vapor vents shall be installed on VJ piping only when the source of liquid nitrogen is a bulk tank. We DO NOT recommend to use vapor vents when the source of liquid nitrogen are liquid cylinders. Vapor vents increase cryogenic consumption beyond what liquid cylinders can sustain.

Vapor vent heater preventing ice build ups

The problem: Ice buildup

The nitrogen gas coming out of a vapor vent device is often extremely cold. It is not uncommon to see temperatures falling below -140 degrees Fahrenheit. Direct skin contact with the vent discharge of the vapor vent device will result in severe burns.

A more common problem with vapor vent devices is ice building up on the vent pipe. Any moisture contained in the atmospheric air coming in contact with the vent pipe will freeze automatically and accumulate over time.

The solution: Vapor vent heater

The vapor vent heater connects to the vent pipe of the vapor vent device via a bayonet. The band heater is installed at the end of the unit and warms up the cold nitrogen gas before being released into the atmosphere. **Warning! The heater can become extremely hot.** A protective sleeve is installed around the exposed portion of the heater to protect personnel from being burnt by the band heater.

The vapor vent heater is normally sold as part of a complete vacuum jacketed piping system.

Installation of a vapor vent heater

In this example, the end-of-line vapor vent device is installed on the roof. The VJ piping is sloped at a rate of 1/8" per 12" of pipe run, which forces the gaseous nitrogen to reach the vapor vent device while keeping the liquid nitrogen lower in the VJ piping.

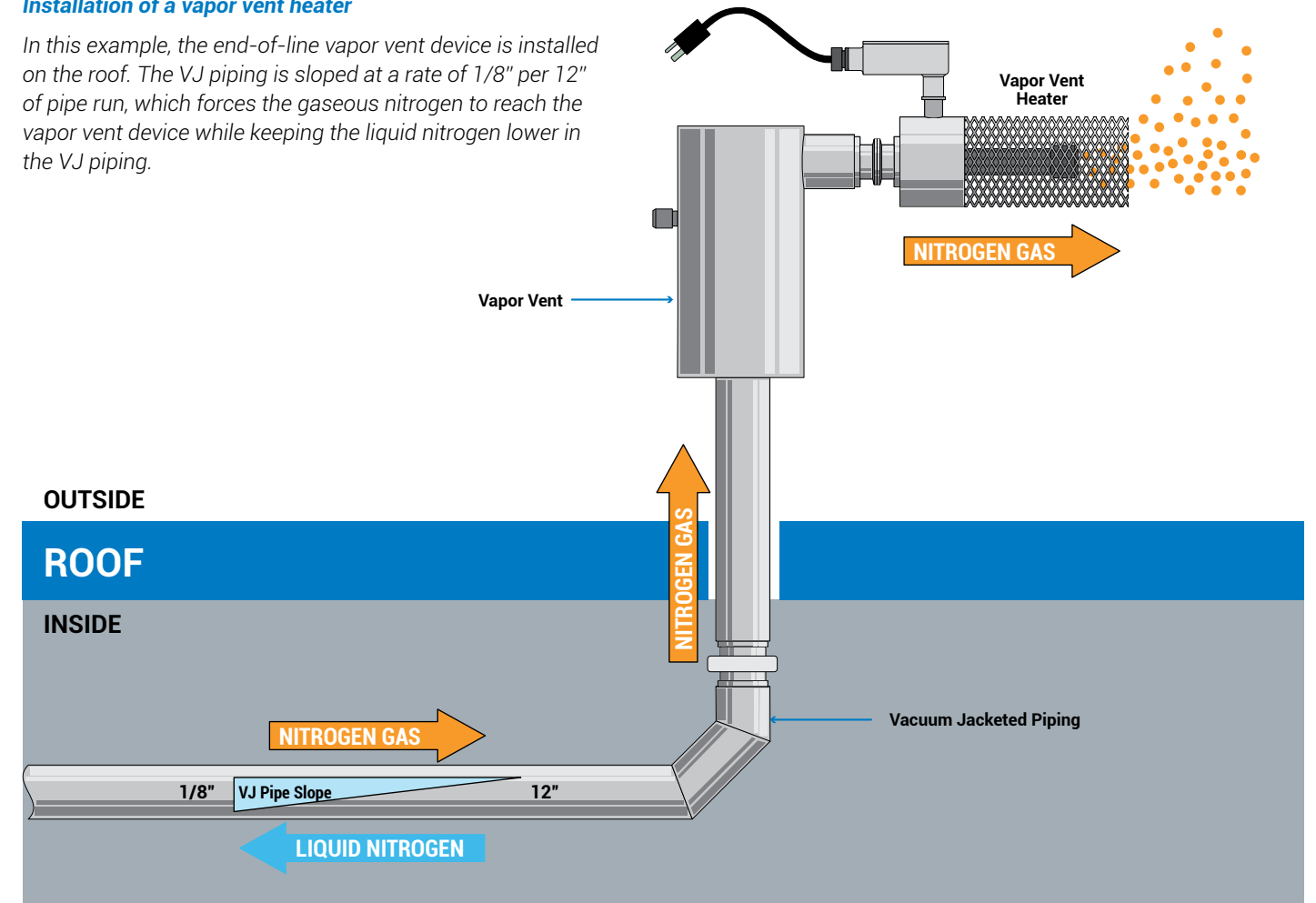

Non-vacuum insulated components

There are several cryogenic components that are not vacuum jacketed. Outside of their low cost compared to their vacuum jacketed counterparts. They all have one very specific thing in common: high heat loss/transfer (they freeze up and they are often smothered under ice). Below are some of the non-vacuum jacketed piping components and their specifics.

Cryogenic solenoid valve

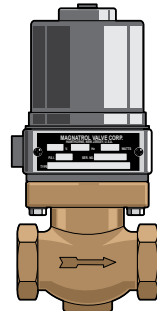

These valves are available in normally open or normally closed positions. They can be ordered with pretty much any coil wattage.

Non-vacuum insulated cryogenic globe valve

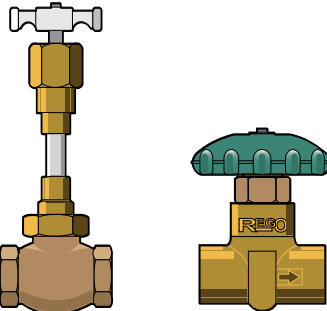

These valves are normally found under cryogenic bulk tanks. Their sizes, shapes and styles vary greatly upon manufacturers.

Thermal expansion pressure relief valve

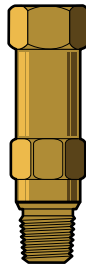

Also known as "pop safeties", the thermal expansion pressure relief valves are extensively used on VJ piping systems. These valves are used everywhere there is a possibility to trap cryogenic liquids between two closed ends. These relief valves are not available in a vacuum insulated version.

Non-vacuum insulated cryogenic globe valve

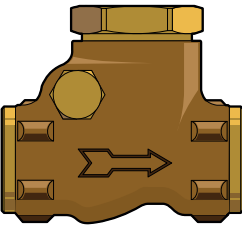

A vacuum insulated cryogenic check valve does not exist. There are two (2) popular cryogenic check valves: the spring loaded check valve and the swing check valve (shown above).

Typical non-insulated cryogenic liquid metal hose

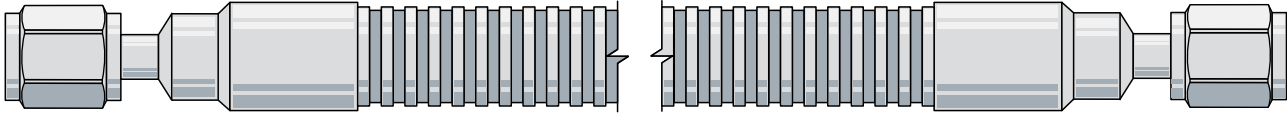

These cryogenic metal hoses are very popular due to their low cost compared to their vacuum jacketed version. The user shall understand though that these hoses are the most important source of heat leak into a cryogenic system (heat leak = cryogenic liquid evaporation).

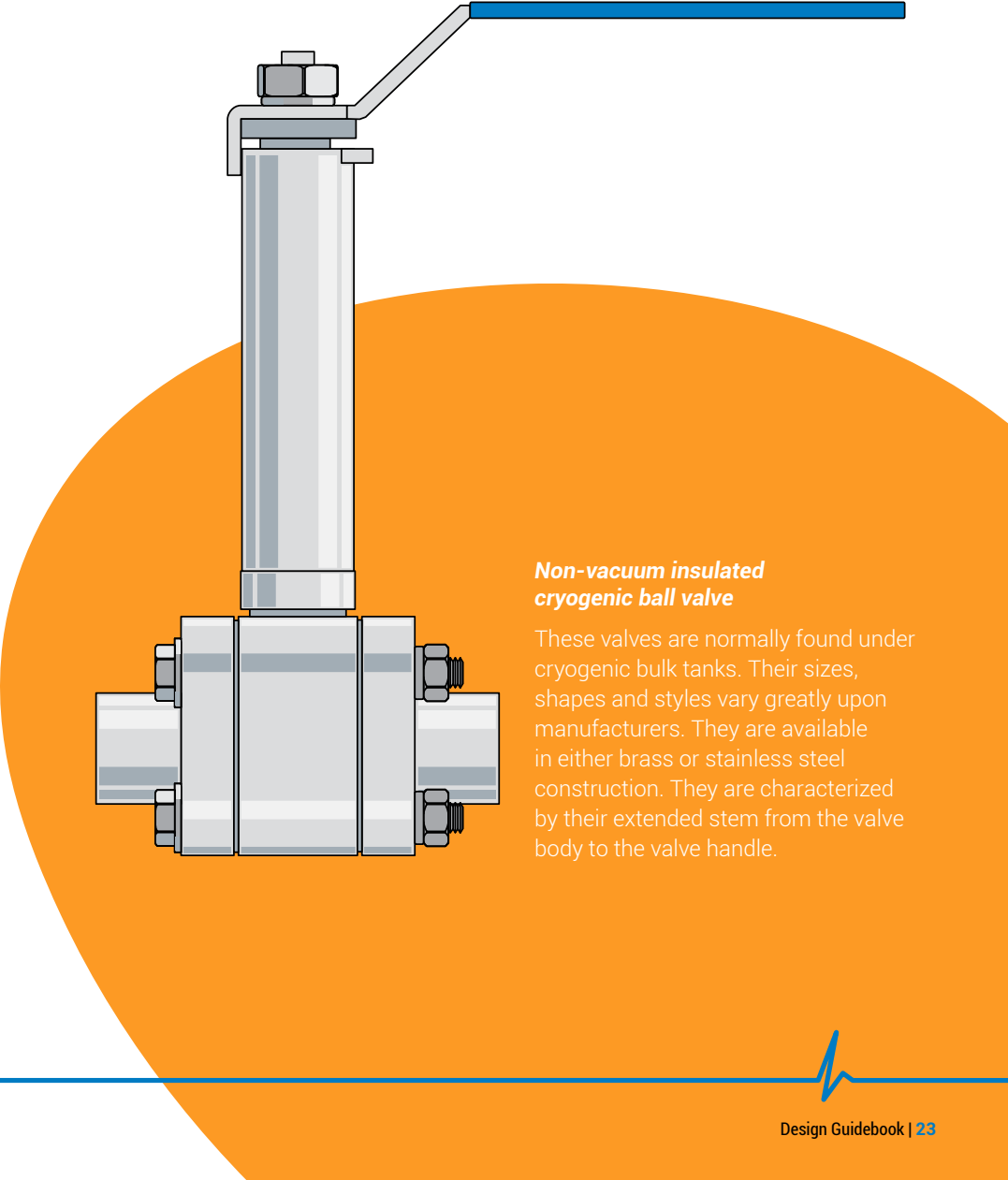

Non-vacuum insulated cryogenic ball valve

These valves are normally found under cryogenic bulk tanks. Their sizes, shapes and styles vary greatly upon manufacturers. They are available in either brass or stainless steel construction. They are characterized by their extended stem from the valve body to the valve handle.

Fully automatic **switchover** manifolds cryogenic liquid withdraw & dispense

Typical cryogenic fully automatic switchover manifold
- Temperature actuated (CFAM-TX)

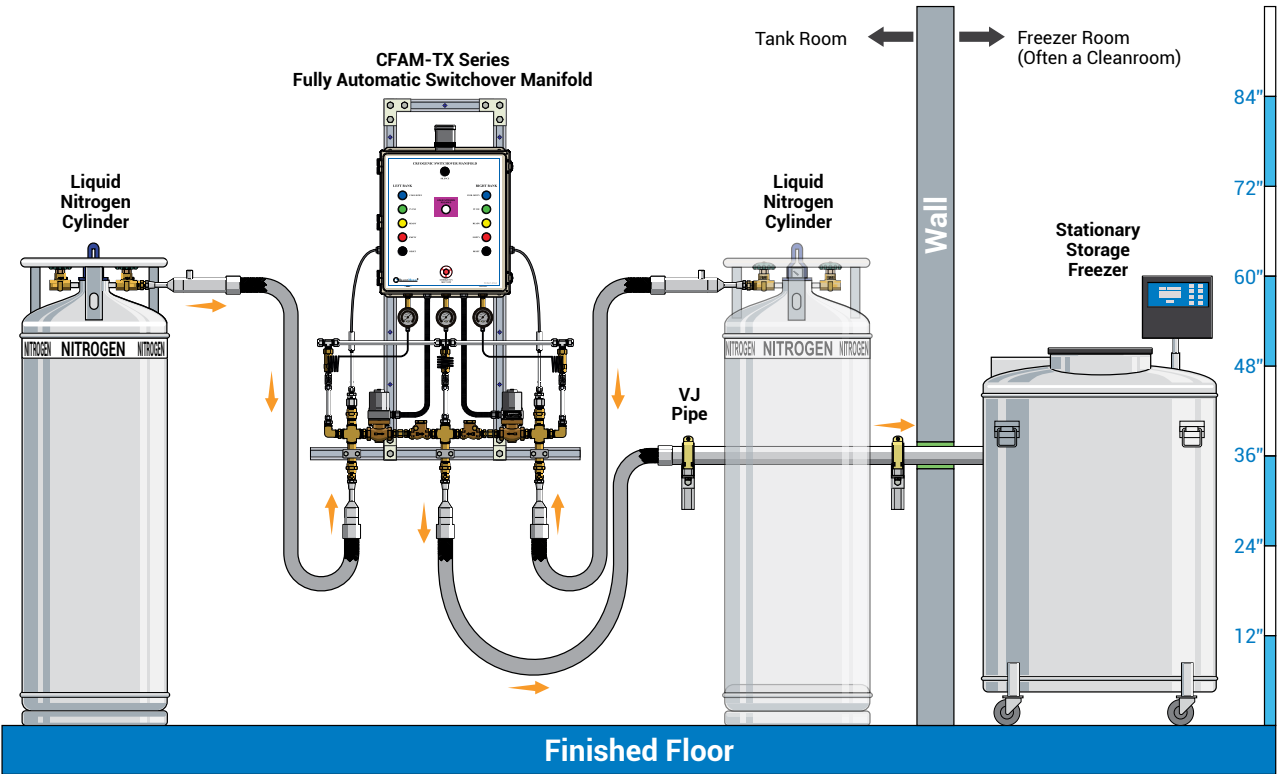

Cryogenic fully automatic switchover manifold
- Weight actuated (CFAM-WX)

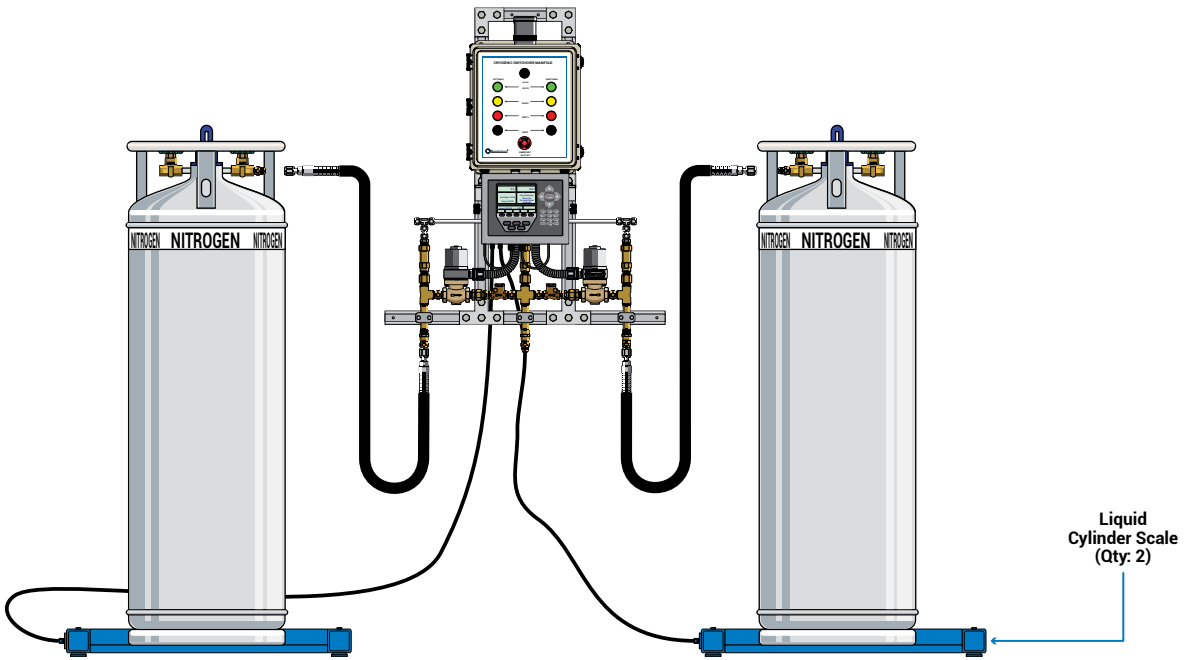

Cryogenic fully automatic switchover manifold
- Pressure actuated (CFAM-PX)

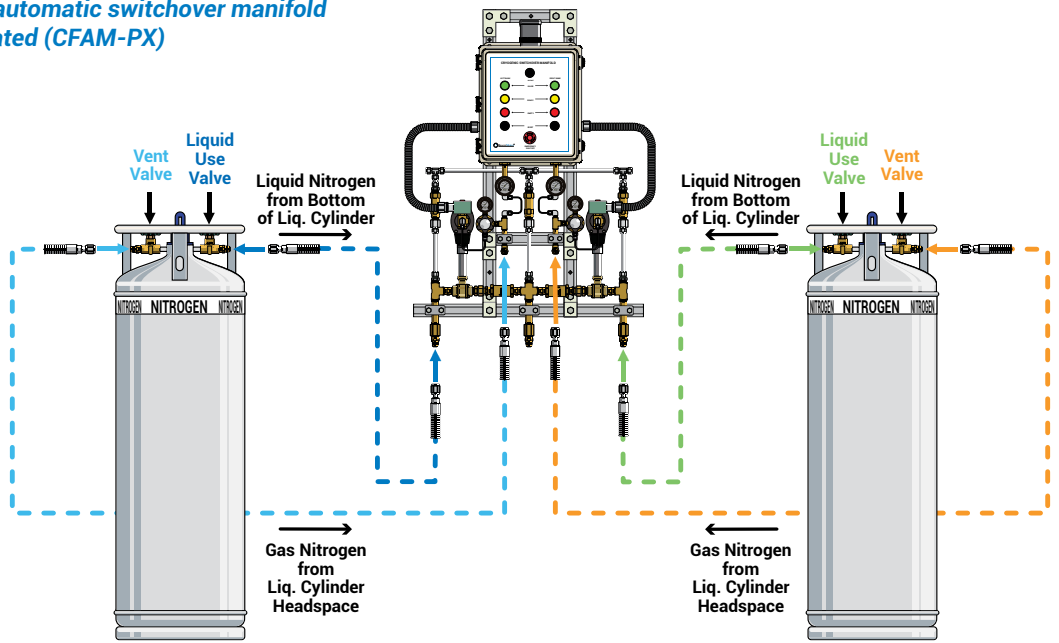

The three (3) BeaconMedæ series of cryogenic liquid switchover manifolds

Series	CFAM-TX	CFAM-PX	CFAM-WX
Actuation	by temperature & pressure	by pressure only	by weight of liquid only
How it works	Switchover occurs when both temperature and pressure do not meet predetermined set points	Switchover occurs when the liquid cylinder pressure drops below a predetermined pressure	Switchover occurs when the cryogenic liquid weight inside the cylinder drops below a predetermined set point
Primary benefit	Reliable and cost effective cryogenic delivery manifold	Designed for applications requiring a lot of gas from liquid cylinders (requires vaporizers)	Displays the exact amount of cryogenic liquid inside each liquid cylinder at any given time
Primary limitation	Slow to respond due to its 90-second supply cycle	Not designed for low pressure cryogenic liquid applications	The most flexible and fastest responding manifold is also the most expensive
Where to use it	Liquid nitrogen storage freezers	Supply gas oxygen to hyperbaric chambers	Any type of applications requiring cryogenic liquid delivery or high flow gas delivery

Automatic filling liquid cylinder fill station

Automatic liquid cylinder fill station arrangements

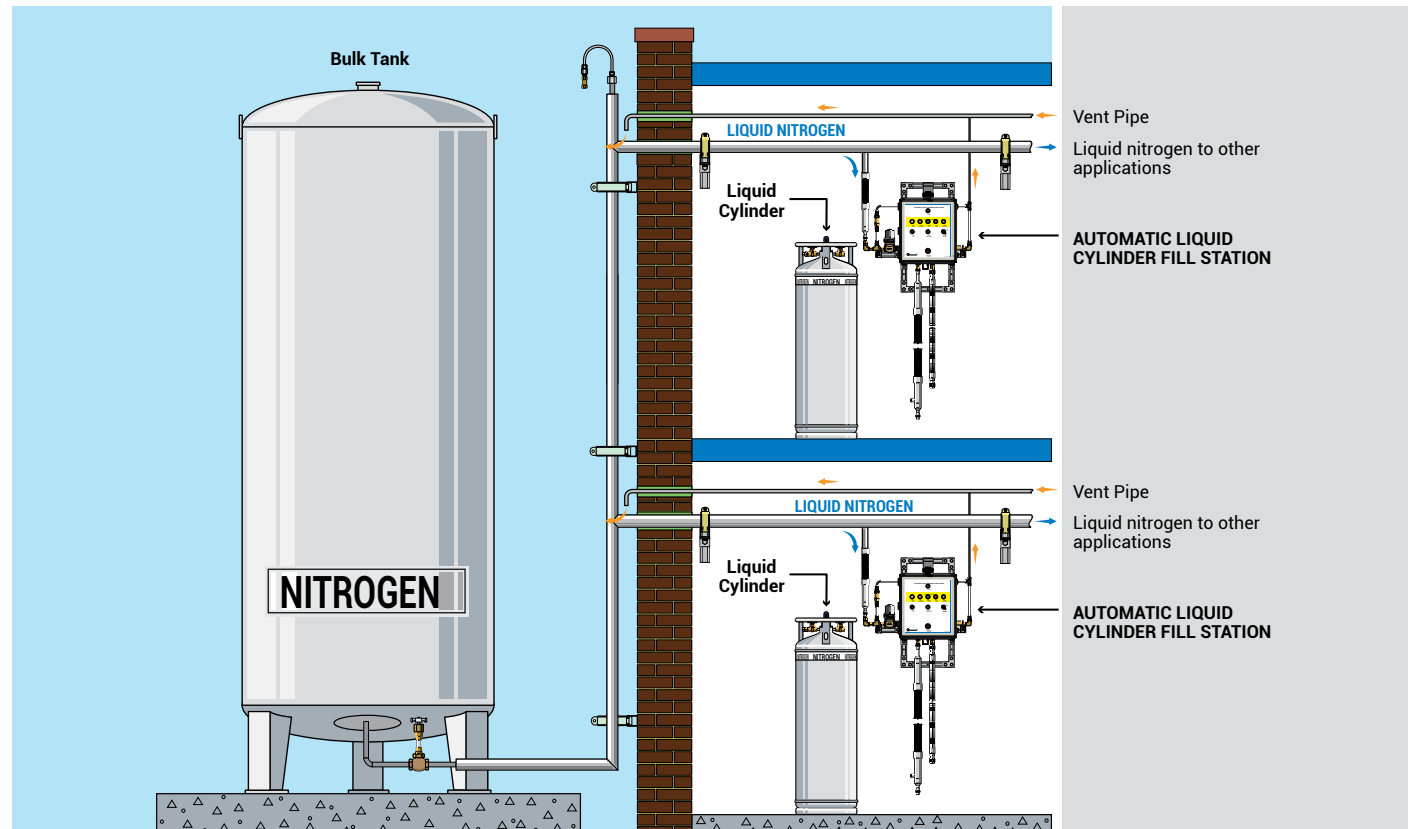

Connecting the automatic filling station to the liquid cylinder

Liquid cylinders are DOT-rated pressurized containers. Most liquid cylinders have four valves labeled as follow:

- Gas use
- Liquid use
- Vent
- Pressure build

Liquid cylinders are filled with cryogenic liquids via the "Liquid Use" valve. The "Vent Valve" is used to allow gas to escape during the filling process.

How do we know when a liquid cylinder is full?

The temperature probe takes the temperature of the gas that is being vented out of the liquid cylinder. The filling process stops when the temperature of the gas coming out of the vent valve drops below a certain level.

Key points for a good liquid nitrogen delivery system for this application

- Many times over, automatic liquid cylinder fill stations are fed at a pressure above 35 psig. System designers shall pay a special attention to this details as several other cryogenic applications cannot withstand pressures above 22-25 psi. This is particularly true for controlled rate freezers and many stationary cryogenic storage freezers
- Speed of filling is closely linked to the pressure of cryogenic liquid inside the piping. If the liquid cylinder filling station is located on a "higher" floor. The system designer shall consider a pressure loss due to gravity of about .6 to .8 psi per foot of height the cryogenic liquid has to climb
- Keeping all components vacuum jacketed will greatly improve the overall liquid nitrogen consumption

Temperature control unit (Keepcool) - The time saver

The problem: Long VJ piping cool down time

Stationary storage freezers are very good at minimizing liquid nitrogen to boil off. Their high efficiency means that the interval between two (2) filling cycles could be days. That leaves plenty of time for the liquid nitrogen remaining inside the VJ piping to evaporate and vent out through the safety relief valves. That also could be enough time for the VJ piping to warm up to ambient temperature.

When a cryogenic storage freezer is calling for liquid nitrogen. A lot of nitrogen and time are required to bring the temperature down to cryogenic temperature. It is only then that the freezer is being filled up with liquid nitrogen. In some cases, this cool down period is long enough to prevent the freezer to be filled on time and cause a fill time alarm by the freezer.

The solution: Temperature control unit

The KeepCool has been designed for a very specific purpose; reducing the time it takes to cool down a vacuum jacketed pipe. This task is achieved by keeping the temperature inside the vacuum jacketed pipe at a low temperature without being flooded by liquid nitrogen.

This system is particularly suitable when the source of liquid nitrogen is liquid cylinders. The KeepCool uses both very cold nitrogen gas to maintain the temperature inside the piping halfway between ambient temperature (say 70°F) and the cryogenic temperature of liquid nitrogen (-319°F).

The KeepCool unit is setup at the factory to keep the temperature inside the VJ piping between -70°F and -90°F.

Recommended TCU installation

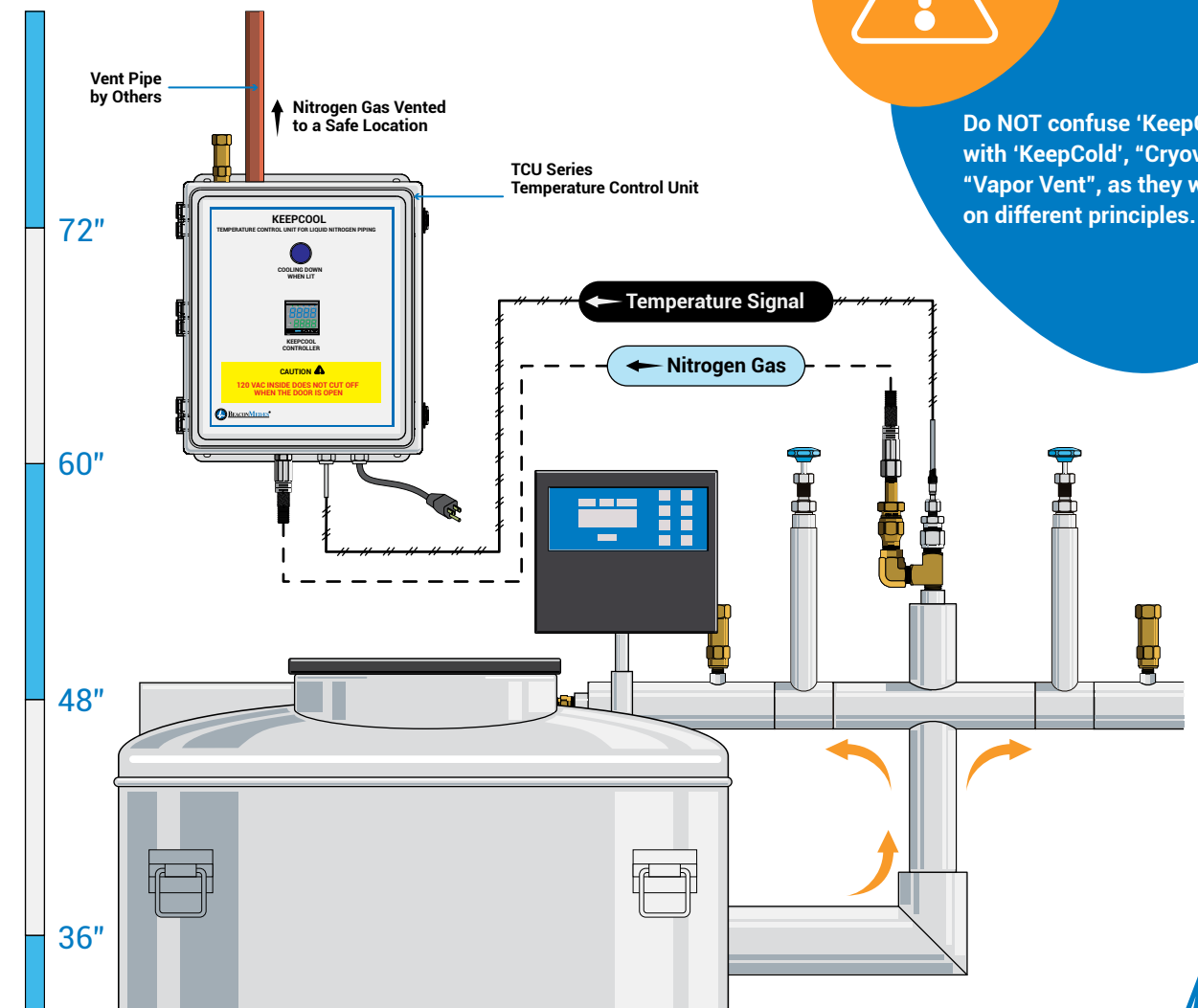

The pusher - Controlling the pressure of a liquid cylinder

Role of the Pressure Relief Valve in a liquid cylinder

The role of the pressure relief valve is to prevent the cryogenic liquid cylinder to build-up too much pressure inside the inner vessel. The PRV is directly connected to the gas phase of the cryogenic liquid cylinder. The increase of pressure is essentially caused by three (3) main phenomena:

- a) The internal pressure build-up circuit inside the liquid cylinder.
- b) The heat exchange between the cryogenic liquid and the ambient atmosphere.
- c) A combination of a) and b).

Standard configuration

Cryogenic liquid cylinders are generally delivered with one (1) pressure relief valve from the factory. The second pressure relief valve can be ordered as an extra or added by the gas companies.

Dual Pressure Relief Valve Assembly

Having a low and a high pressure relief valves on a liquid cylinder is a very practical way for gas companies to allocate a liquid cylinder to either a liquid withdraw mode or a gas withdraw mode. The high pressure relief valve is always live. The low pressure relief valve (generally set at 22 psi) is isolated by a ball valve. For liquid withdraw mode, the gas company or the end user shall open the isolation ball valve mounted upward of the 22 psi pressure relief valve. In that case, the pressure building valve shall remain closed.

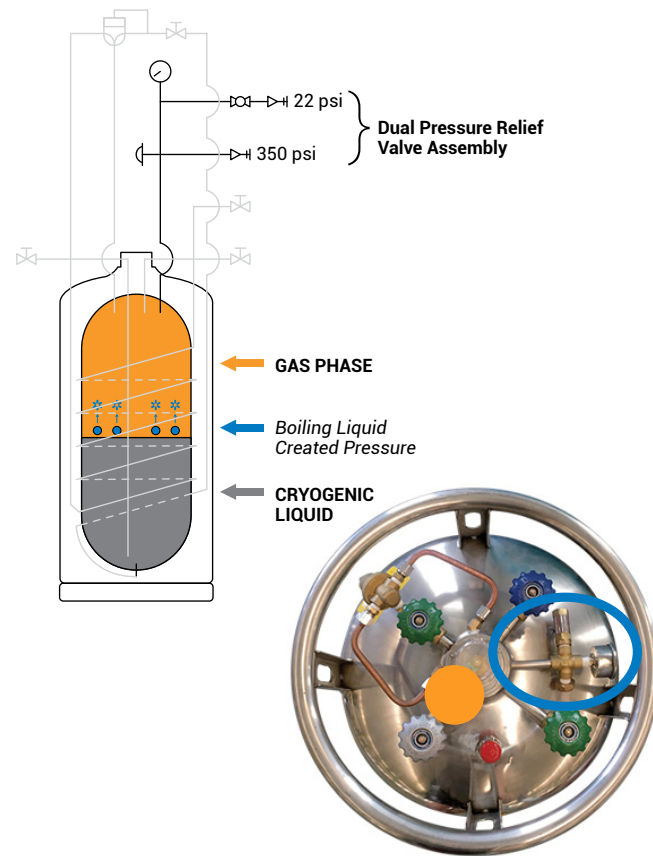

Liquid cylinder shown with one (1) relief valve (Standard Configuration)

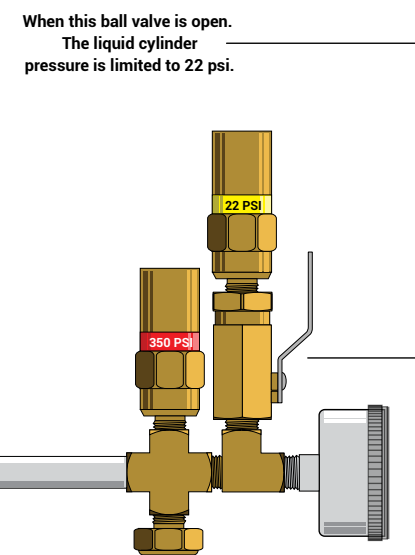

The Problem: Liquid cylinder pressure control

Pressure control of liquid cylinders could be a real challenge. Liquid cylinders come with two kinds of pressure setting: low pressure (mounted with 22 psi relief valve) and high pressure (mounted with either 230 psi or 350 psi relief valves). No matter the type of liquid cylinders, rarely liquid cylinders arrive at end user facilities at the same pressure even if they are mounted with the same relief valve pressure.

Storage freezers - Storage freezers perform better when liquid nitrogen is fed to them anywhere between 22 and 40 psig. This pressure range is above the PRV set point of low pressure liquid cylinders. The same pressure range is definitely too low for high pressure liquid cylinders.

Controlled rate freezers - Controlled rate freezers are heavily relying on stable and adequate pressure and flow of the liquid nitrogen supply to have successful runs. Longer VJ piping can make flow and pressure to become hard to control.

Recommended TCU Installation

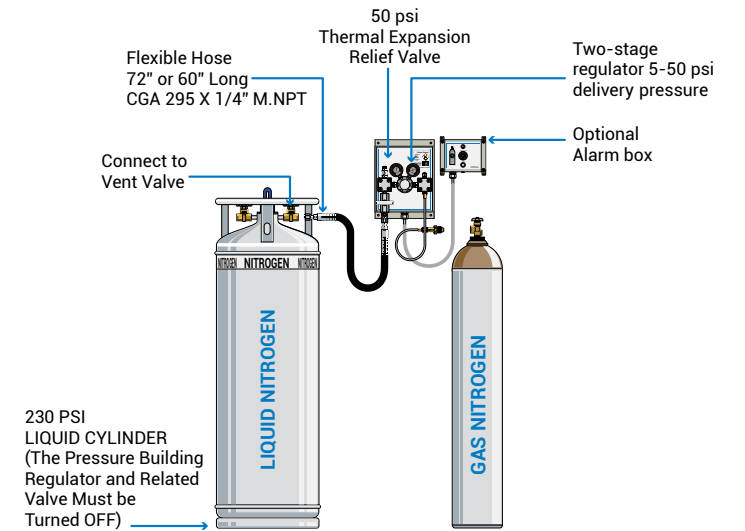

The Solution: The Pusher

The pusher is a pressure reducing regulator mounted on a panel with hoses and a safety relief valve. When connected to the VENT VALVE of a liquid cylinder, the regulator allows the operator to adjust and maintain the pressure of the liquid cylinder.

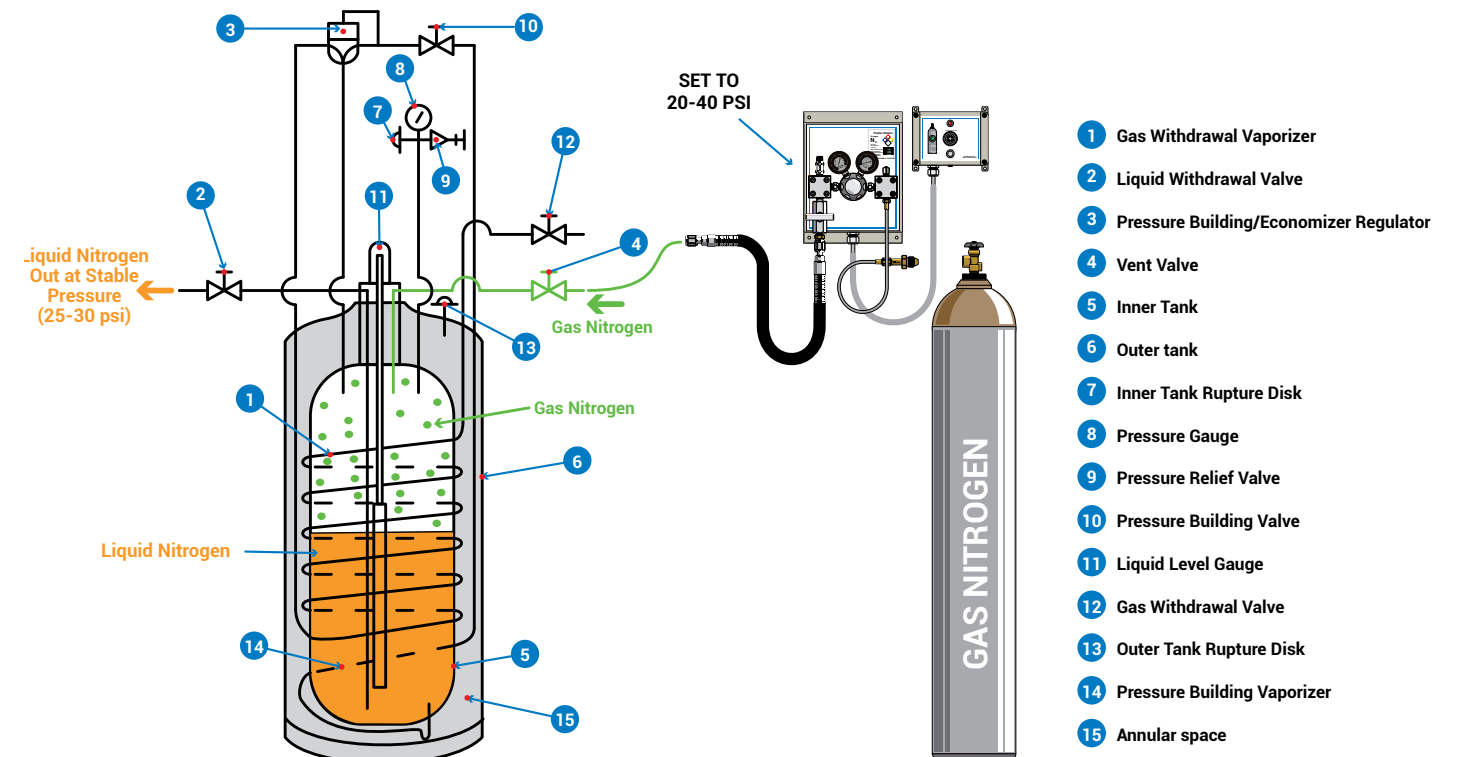

Vent kits

Balancing pressure between several liquid cylinders

Liquid cylinder pressure without vent kits
(inefficient & traditional way)

Max. Flow: 6 scfm (350-360 scfh)

Here is what is happening:
Gas is drawn from only one liquid cylinder at a time because the liquid cylinder with the highest pressure always gets emptied first. In this case, you will rarely get more than 6 cfm (about 350-360 cfh).

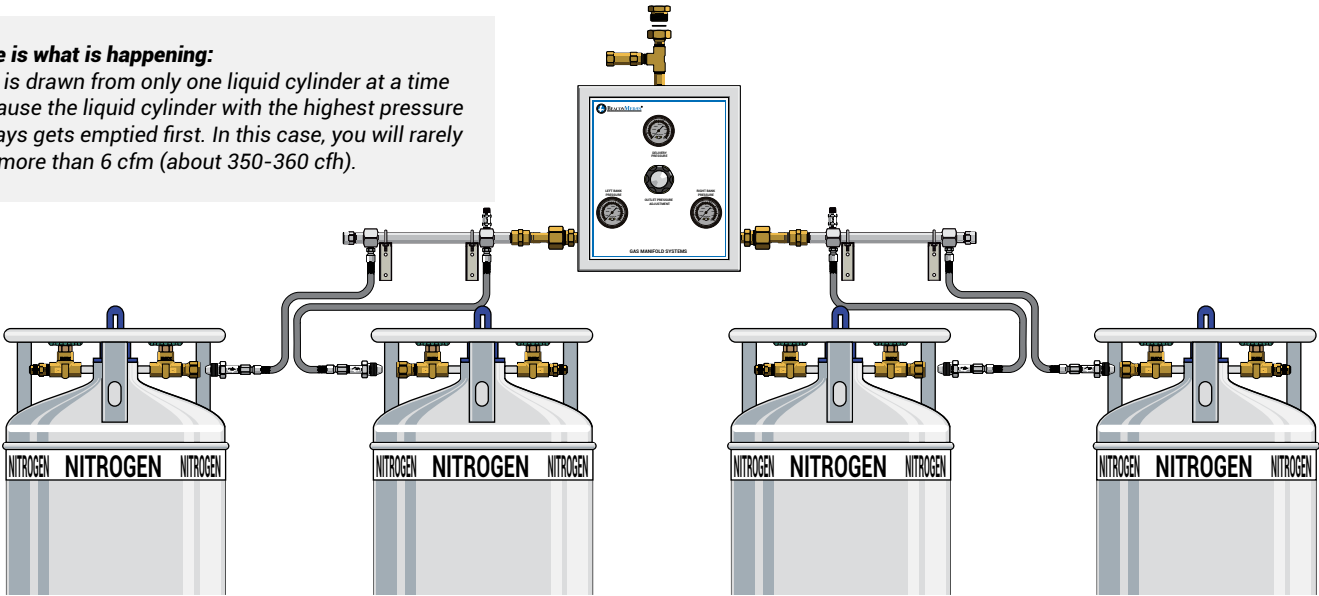

135 PSI
Will empty **second**
when in service
Max. Flow: 6 cfm

147 PSI
Will empty **first**
when in service
Max. Flow: 6 cfm

112 PSI
Will empty **second**
when in service
Max. Flow: 6 cfm

153 PSI
Will empty **first**
when in service
Max. Flow: 6 cfm

Liquid cylinder pressure with vent kits

Max. Flow: 12 scfm (700-720 scfh)

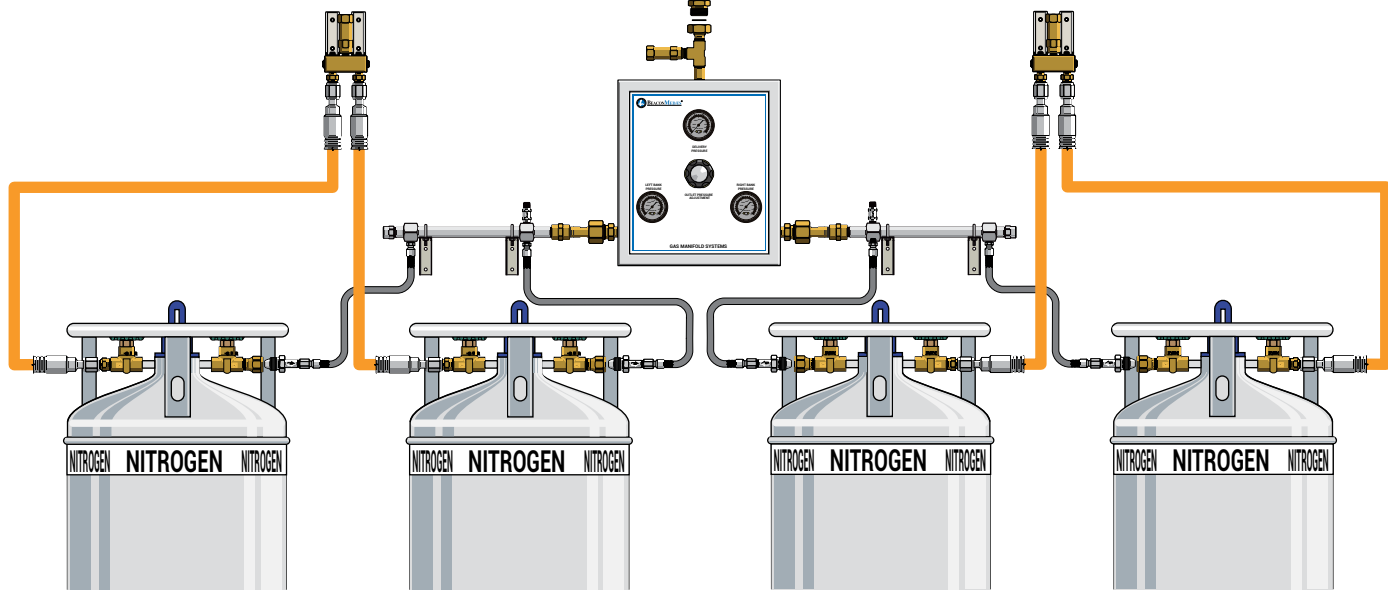

Max. Flow: 6 scfm
Original Pressure: 135 PSI

Max. Flow: 6 scfm
Original Pressure: 147 PSI

+

Max. Flow: 12 scfm
New Equilibrium Pressure: 141 PSI

Max. Flow: 6 scfm
Original Pressure: 112 PSI

Max. Flow: 6 scfm
Original Pressure: 153 PSI

+

Max. Flow: 12 scfm
New Equilibrium Pressure: 133 PSI

Because the liquid cylinders are now at the same pressure:

- Both liquid cylinders will deplete equally
- Maximum flow rate doubles

Because the liquid cylinders are now at the same pressure:

- Both liquid cylinders will deplete equally
- Maximum flow rate doubles

Ambient vaporizers

Turning small volume of liquid into a lot of gas

Automatic liquid cylinder fill station arrangements

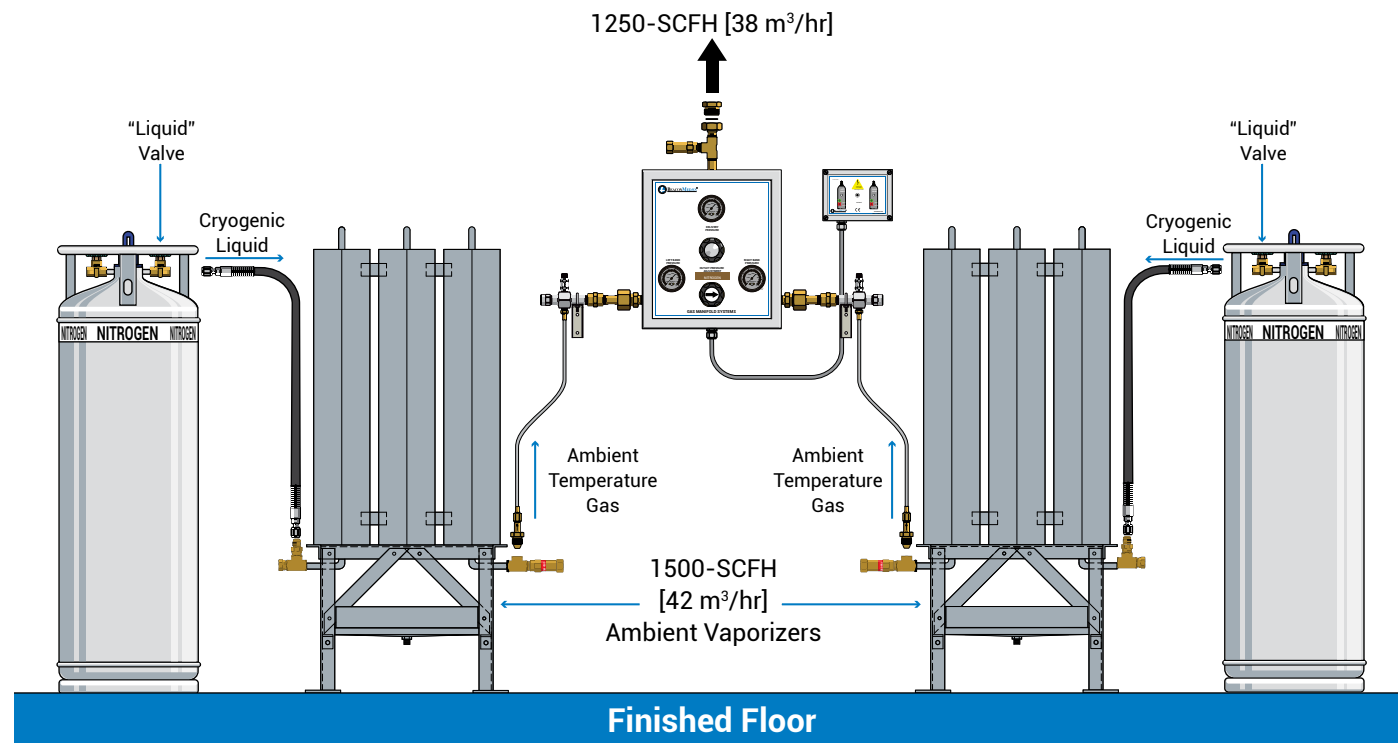

The Problem: Limited liquid cylinder vaporizing capacity

Each liquid cylinder is equipped with a vaporizer located inside the annular space (between the outside shell and the internal tank).

Argon, Nitrogen, Oxygen : 5.8 SCFM / 350 SCFH
Carbon Dioxide : 1.7 SCFM / 100 SCFH

If the flow of gas exceeds the above levels. The liquid cylinder will show signs that the capacity internal vaporizer is exceeded. The end result is withdrawal of liquid in a short period of time.

The Solution

The addition of an external vaporizer (ambient or electrical type) of a greater capacity of the internal liquid cylinder vaporizer is the best way to prevent internal vaporizer to freeze up. Furthermore, more flow of the liquid cylinder will come out from the liquid cylinder (up to the maximum capacity of the additional external vaporizer).

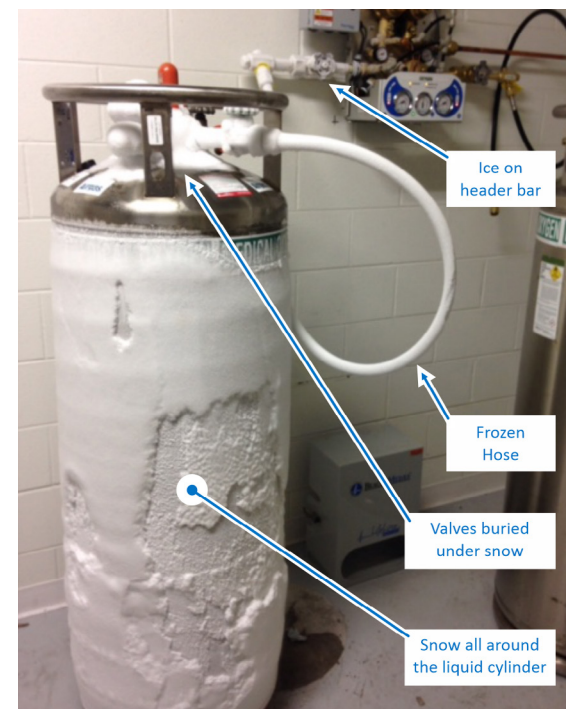

Sign of liquid cylinder overshoot

Applications

Controlled Rate Freezers (CRF)

More complicated than they look

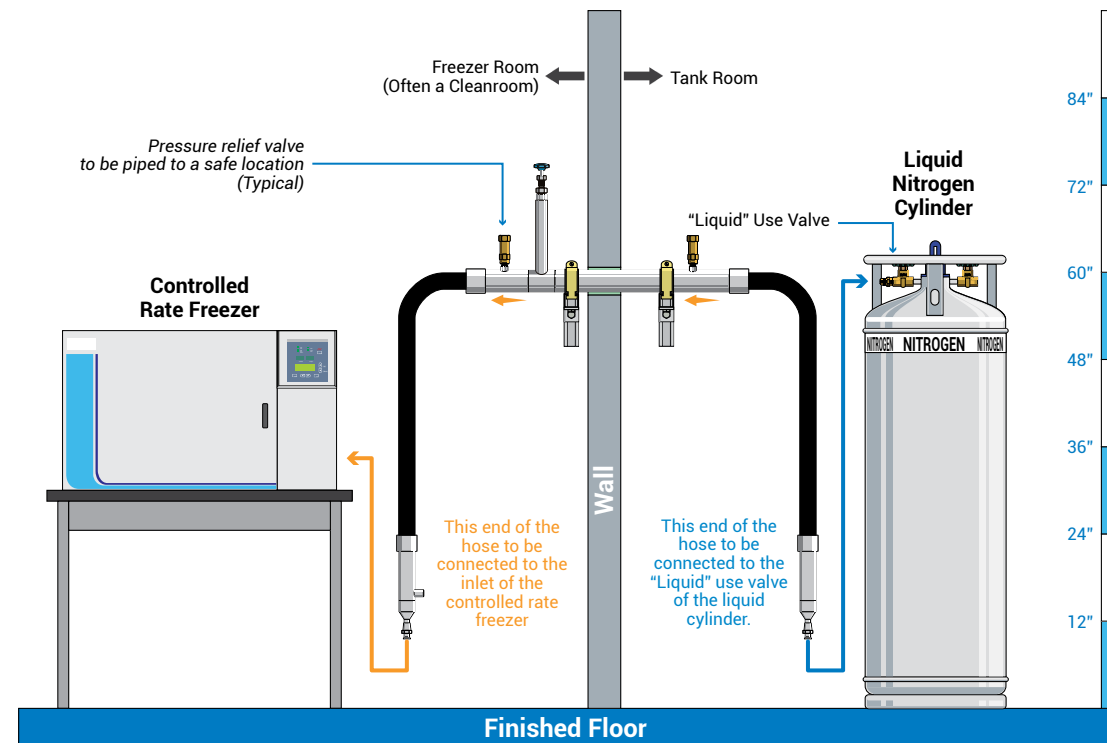

The freezing process of a CRF?

The freezing process in a CRF has to happen in specific phases to prevent damages to the cells. The cells are in suspension in a liquid called cryo-protectant.

Nucleation

At first, extra-cellular ice starts to form as the temperature goes down. At this stage, the CRF is required to decrease the temperature rapidly to overcome the latent heat generated by this ice formation. This is done by injecting a lot of liquid nitrogen inside the CRF. This is called "seeding dip".

Dehydration

Because ice replaces water outside the cell, the water inside the cell migrates outside the cell by osmotic pressure differential (hence cell dehydration).

Safe Freezing Phase

When the cell is sufficiently dehydrated. The temperature is brought down gradually without having formation of lethal intra-cellular ice.

Why is it important to understand this process?

If the cells are cooled down too slow, the cryo-protectant can "poison" the cells. If the cells are cooled down too fast, intra-cellular ice will form and the membrane of the cells can be damaged.

Importance of the liquid nitrogen supply

Repeatability and predictability are key to a successful CRF cycle. As far as the liquid nitrogen supply system is concerned. It is important to bring to the controlled rate freezer good quality liquid nitrogen rapidly, at a constant flow, without interruption, and at a sufficient pressure.

Key points to a good liquid nitrogen supply system for this application

- Do not use switchover manifolds to feed a CRF. A dedicated liquid cylinder connected directly to a CRF is best when possible
- Do not connect other liquid nitrogen consuming devices (particularly stationary freezers) on the piping feeding a CRF. Flow to the CRF will be disturbed
- Keep the distance of piping/hose between the source and the CRF as short as possible. 20 feet is considered long
- Eliminate heat inducing components from the piping/hoses
- Vacuum jacketed components minimize what is called a two-phase flow (gas nitrogen phase and liquid nitrogen phase) reaching the CRF at the same time

Cryogenic storage freezer

Importance of fill time

Beat the clock!

Most - if not all - modern cryogenic storage freezers allow for a maximum of time to get refilled with liquid nitrogen. The maximum fill time varies greatly upon the model and make anywhere between 30 minutes and 90 minutes.

It is important to keep in mind when a freezer needs to be refilled, the freezer is NOT actually empty. The freezer has low set point and a high set point as explained below. Filling a freezer simply mean the level of liquid nitrogen has to be filled from the low set point to the high set point.

If the liquid nitrogen level is not reached within the maximum fill time, the cryogenic storage freezer will automatically fall into alarm or fail mode. Those freezers are often - if not all the time - connected to an external computer monitoring and logging the fill cycles and temperature of the freezers. It is very common to see freezers connected to an automatic phone dial warning personnel (day or **night**) when they are in alarm.

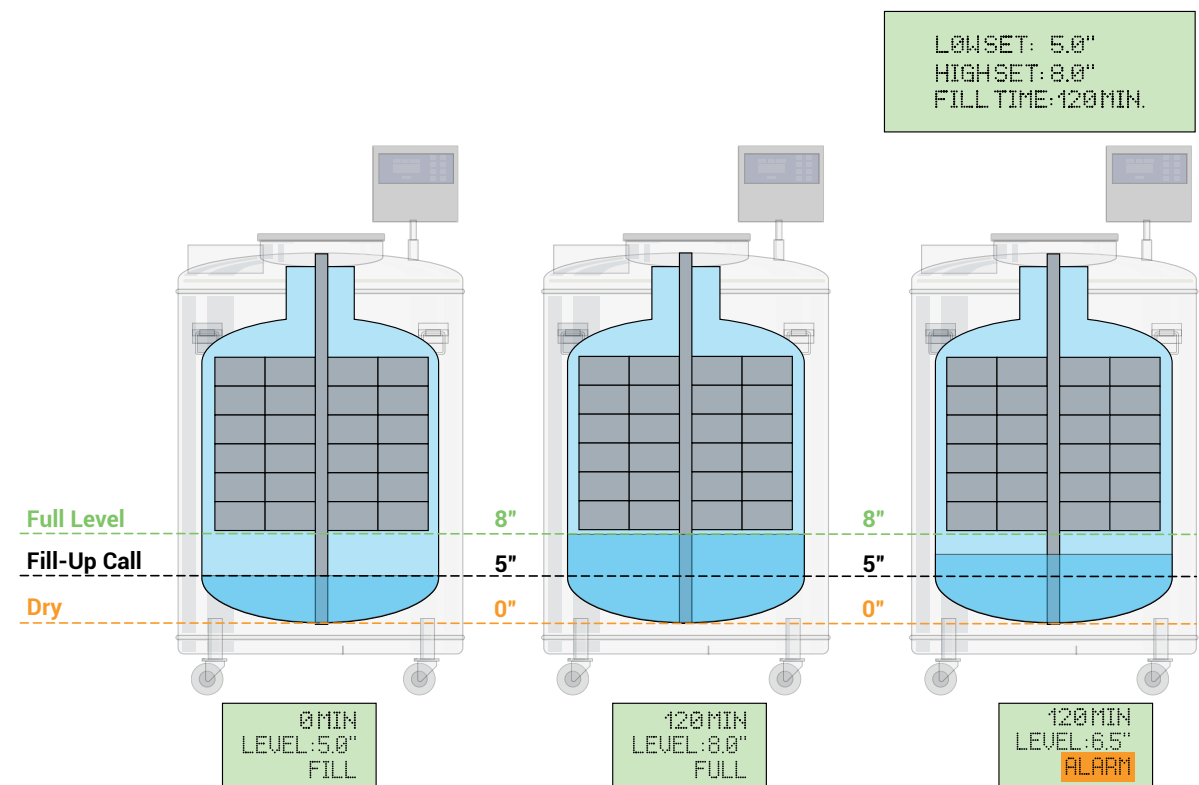

The time sensitive stationary storage freezers

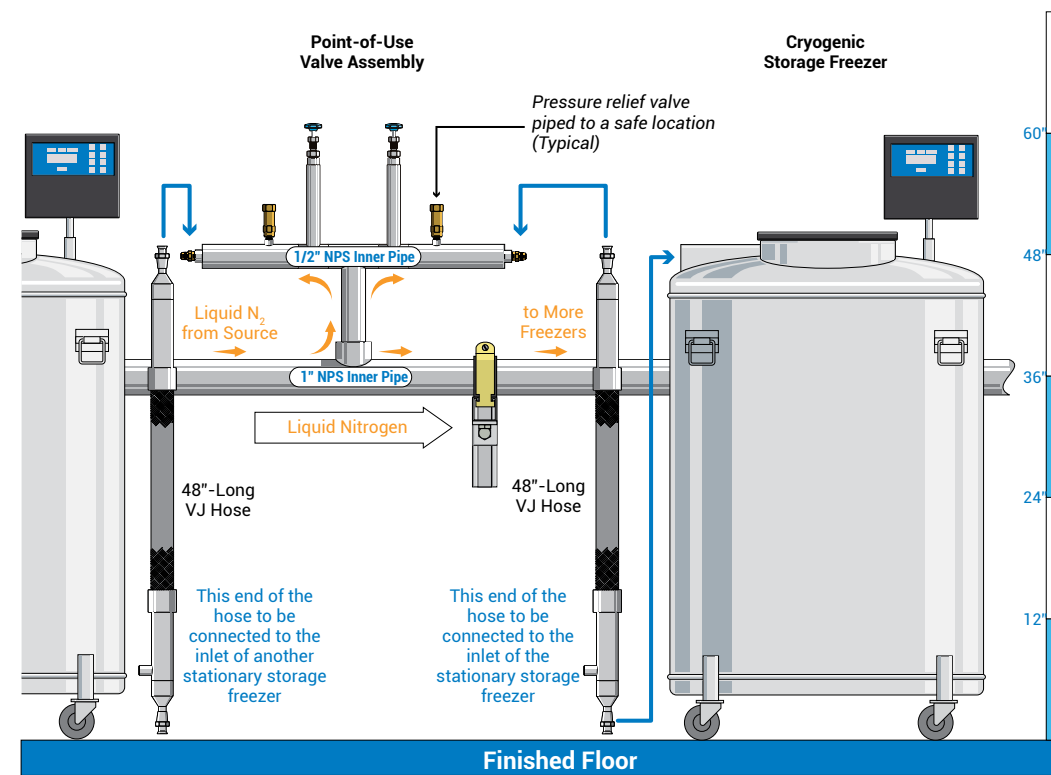

Stationary freezers explained

Stationary freezers store a large quantity of species at very low temperature. It is important to know that 50% of the available BTUs released by nitrogen happen in the gas phase and 50% in the liquid phase. That is why, and contrary to popular belief, the species are not in contact with liquid nitrogen. Species are in contact with cold gas nitrogen in stationary freezers.

Only the bottom of a stationary freezer is filled with liquid nitrogen. The liquid nitrogen boils off and very cold gas nitrogen “floats” inside the dry portion of the freezer containing the species.

When does a stationary freezer call for liquid nitrogen?

Let’s take a stationary freezer with an internal vessel of 36” long. This internal vessel would be considered “full” of liquid nitrogen when the bottom 8” contains liquid nitrogen. The freezer will call for liquid nitrogen when the top 4” of liquid nitrogen is gone leaving 4” of liquid nitrogen at the bottom of the internal vessel.

Limited fill time

Let’s continue with the same example. Now the stationary freezer is calling for liquid nitrogen to bring the level from 4” up to 8”. Depending on the brand of the storage freezer, this fill time can be limited anywhere between 30 minutes and 90 minutes. If the freezer is not replenished with liquid nitrogen within that fill time, the storage freezer will stop the filling process and fall into alarm mode.

Key points for a good liquid nitrogen delivery system for this application

- Keep the flow and pressure high enough (between 20-40 psig) throughout the piping network to fill the last-in- line stationary freezer within the allowed fill time
- Do NOT oversize the pipe size to keep to a minimum the liquid nitrogen consumption necessary to cool down the carrier pipe
- Keep to a minimum parts and components that are not vacuum insulated. That will reduce the heat loss tremendously
- You may want to have multiple smaller systems instead of having a very large system (particularly when the source of liquid nitrogen is liquid cylinders)

Manual fill station for liquid nitrogen dewars

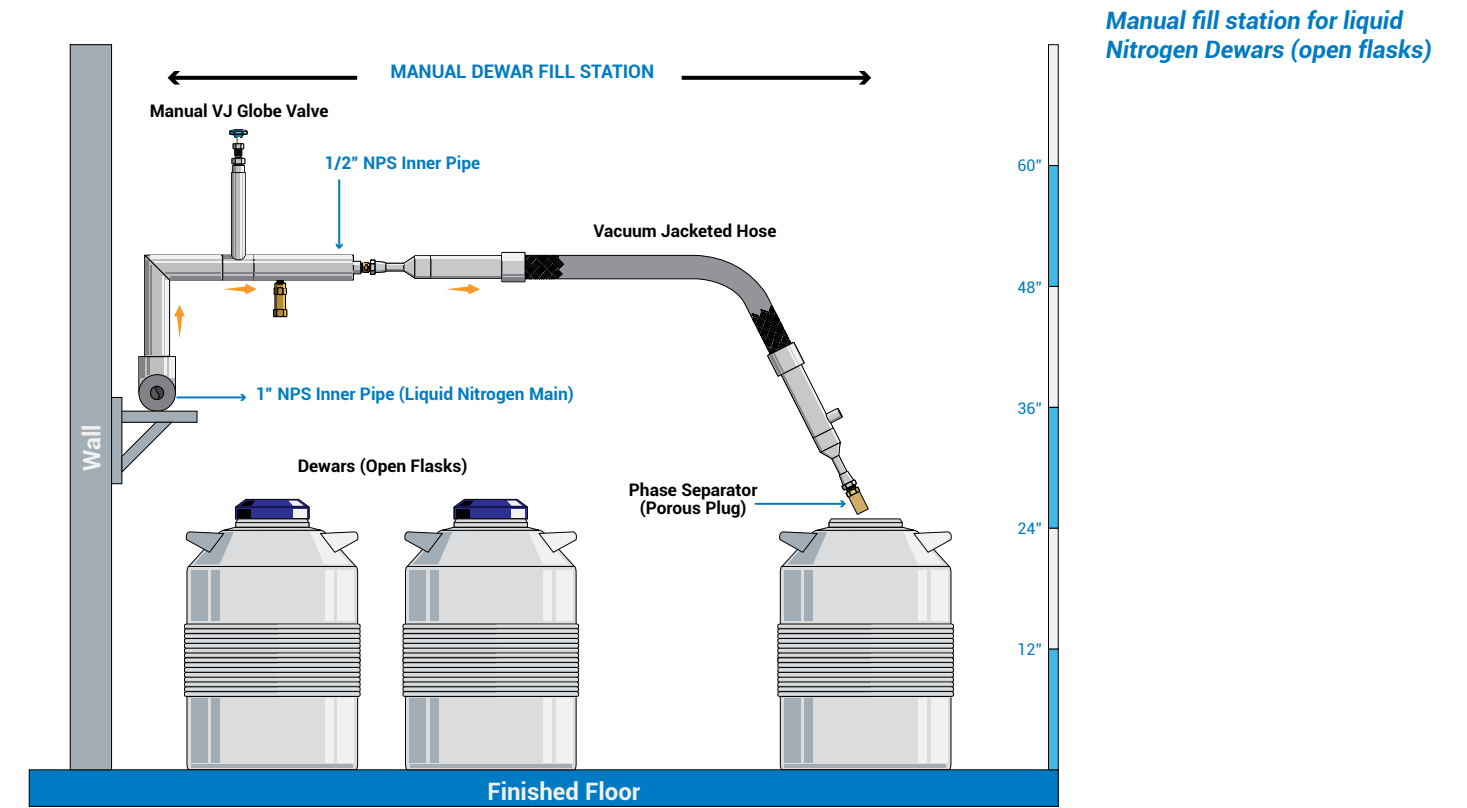

Open flasks (Dewars) description

There are several names given to containers dedicated to store/hold liquid nitrogen. The names vary depending on the end user, the gas companies, the age of the person, just to name a few. The names range from VGL, PGS, liquid cylinders and obviously... dewars.

The name that defines the best an open and unpressurized portable liquid nitrogen containers is “dewar”. Dewars do not come standard with valves or pressure building devices. Dewars generally contain less than 50 liters of liquid nitrogen. They are exclusively filled manually and this process is often done at the end user’s site.

Dewars come standard with lose lids “insulated” with styro-foam which is protected by a cap (made of plastic more often than not). It is by the top opening that dewars are filled by simply pouring liquid nitrogen from a hose mounted with a phase separator at the end to prevent liquid nitrogen from splashing off.

Close to the liquid nitrogen source

Nobody likes to wait. The best place to locate a manual liquid nitrogen fill station is near the source of liquid nitrogen. This is particularly true when the source is liquid nitrogen cylinders or when there is no vapor vent on the piping system.

Key points for a good liquid nitrogen delivery system for this application

- Keep the manual liquid fill station near the source of liquid nitrogen
- Put an isolation valve that can be easily reached by the operator
- Always put a thermal expansion pressure relief valve downstream of the valve even if there are no plans to put another valve or anything else that could trap liquid in the pipe. Plans change over time
- The speed at which dewars will be filled is often related to the components of the manual fill station itself. You may want to consider using vacuum jacketed components such as valves and hoses. Not only you will save time as liquid nitrogen will come out faster but, you will also save a lot of liquid nitrogen due to boil off

VJ piping installation

So simple

Introduction

Installation of static vacuum jacketed (VJ) piping mounted with bayonets is very simple. In fact, it is probably the easiest type of piping to install as it requires no silver brazing, no welding and no special tools.

A section of VJ piping is called a "spool". A VJ piping network is composed of several spools made to length and specifications at the factory. Each spool ends with a male or female **bayonet**. Connecting two spools together is done by inserting the male bayonet of one spool into the female bayonet of the following spool.

Mounting hardware

VJ piping does not require any special hardware. Standard pipe hangers and struts are generally sufficient to hang VJ pipes. The installer is responsible to provide the mounting hardware and labor. The most popular hangers are:



Swivel Threaded-Rod-Mount Loop Hanger



Snug-Hold Threaded-Rod-Mount Clamping Hanger

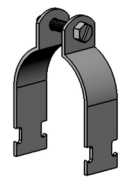

Strut-Mount Metal Routing Clamp

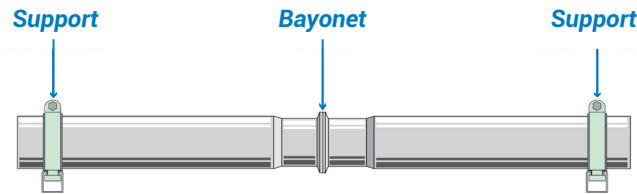

Bayonets

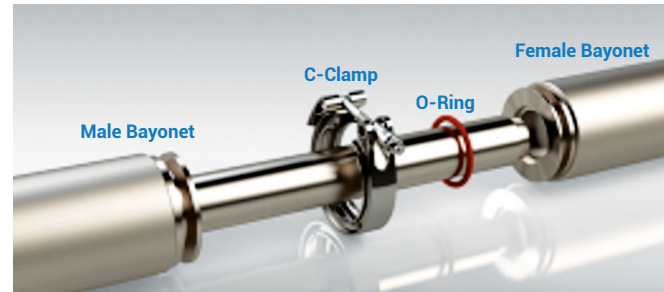

The cryogenic liquid flow direction in the VJ pipe determines which bayonet comes first: the male bayonet is followed by the female bayonet. This is to prevent cryogenic liquid to fill the gap between the mating bayonets to eventually finding its way out. Once the bayonets are coupled. The joint is secured in place by a C-clamp.



The bubble-tight seal of bayonet joints is assured by a combination of the following:

- The o-ring located in the grooved female bayonet flange
- The very tight gap clearance between the female and the male bayonet
- The C-clamp (aka V-band) keeping the joint together

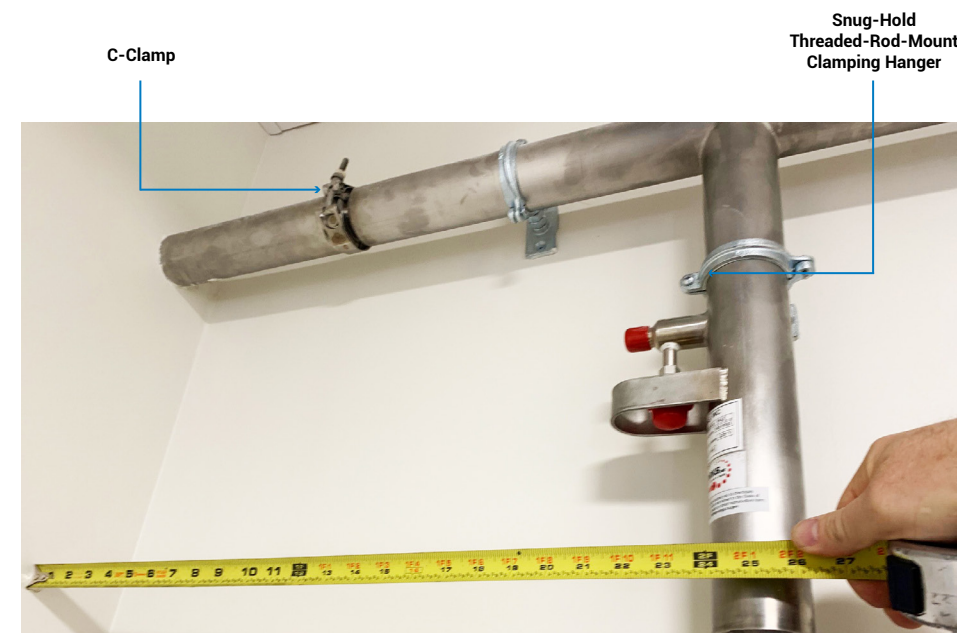
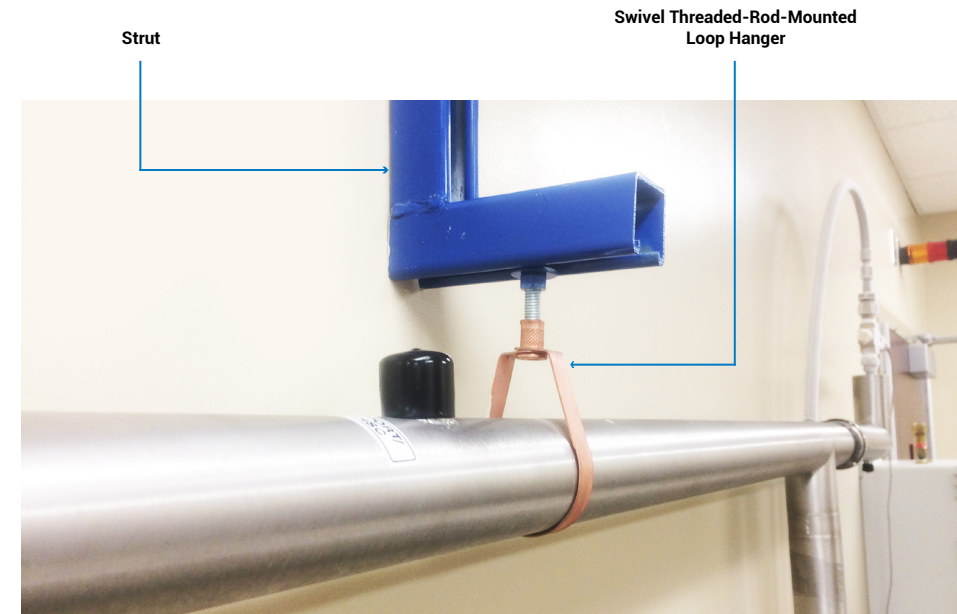



Life is in the details.[®] 



www.beaconmedaeslab.com
© BeaconMedæS December 2020. 2205 6107 18